

ROUTING IN MIXED WIRED AND WIRELESS NETWORKS

APPROVED BY SUPERVISING COMMITTEE:

Dr. Rajendra V. Boppana, Supervising Professor

Dr. Ki Hwan Yum

Dr. Ali S. Tosun

Accepted: _____

Dean of Graduate School

ROUTING IN MIXED WIRED AND WIRELESS NETWORKS

by

ZHI ZHENG, B.E

THESIS

Presented to the Graduate Faculty of
The University of Texas at San Antonio
in Partial Fulfillment
of the Requirements
for the Degree of

MASTER OF SCIENCE IN COMPUTER SCIENCE

THE UNIVERSITY OF TEXAS AT SAN ANTONIO
College of Sciences
Department of Computer Science
December 2004

Acknowledgements

I would like to express sincere gratitude for the time, encouragement and guidance by Dr. Rajendra V. Boppana, my supervisor. His intelligence, insights and hardworking has been very valuable for this thesis and for myself.

Thanks for Dr. Ali S. Tosun and Dr. Ki Hwan Yum for serving on my committee and thanks for all the support from my colleagues and the computer science department in UTSA. I express my gratitude to the Computer Science Division and its staff for extending excellent co-operation at all the times.

May 2004

ROUTING IN MIXED WIRED AND WIRELESS NETWORKS

Zhi Zheng, B.E.
The University of Texas at San Antonio, 2004

Supervising Professor: Dr. Rajendra V. Boppana

The last decade has witnessed an explosion in wireless networking technologies such as cellular and Wi-Fi. While these new technologies provide flexible and mobile networkings, they are either expensive or unreliable. So, we believe the future local and metropolitan area network will consist of fixed or stationary devices acting as infrastructure nodes and wireless devices connecting mobile users.

Recent advances in technology make such networks feasible and desirable. Such networks can replace DSL/Cable modem or cellular service. Problems to be solved to make such networks viable include the design and update of network hardware devices, the software such as routing protocol, the security mechanism and applications.

Our research focuses on the design of a suitable routing protocol and performance evaluation of networks with mixed broadcast type wireless and point-to-point (p2p) links. In this thesis, we present ADV static (ADVS) routing algorithm which can use both p2p and broadcast (wireless) links to route messages. ADVS is based on the Adaptive Distance Vector (ADV) routing protocol, designed for mobile ad hoc networks. We use simple changes to route selection logic to promote the use of wired links when feasible. We implemented ADVS in the Glomosim simulator, which is widely used in wireless ad hoc network studies. We also modified Glomosim to simulate networks with (a) both wireless and p2p links and (b) mobile and fixed nodes simultaneously.

To evaluate the performance benefits of mixed networks over ad hoc wireless networks, we simulated both types of networks with ADVS as the routing protocol. We considered UDP and TCP traffic patterns. In all cases, the mixed networks provide better throughput and packet delays. The throughput gains with a few point-to-point links added to an otherwise ad hoc network can double throughput and halve packet delays even when point-to-point and wireless links have the same bandwidth.

TABLE OF CONTENTS

Acknowledgements	iii
Abstract	iv
List of Figures	viii
1 Introduction	1
1.1 Next Generation Wireless Networks	2
1.2 Designing and Using Mixed Networks	5
1.3 Contributions of This Thesis	6
1.4 Organization	7
2 Background	8
2.1 Overview of IEEE 802.11 MAC layer	10
2.1.1 Carrier Sense Multiple Access (CSMA) Protocol	11
2.2 Routing Algorithms for Ad Hoc Networks	14
3 Glomosim Simulator	18
3.1 Passing information across nodes	19
3.2 Simulating fixed and mobile nodes together	24
4 A Routing Algorithm for Mixed Wired and Wireless Networks	26
4.1 ADV Static (ADVS) Routing Algorithm	26
4.2 Implementation of ADV Static (ADVS) algorithm	30
4.2.1 Modifications to ADV	30
4.2.2 Route maintenance	31
5 Performance Analysis	34
5.1 Simulation Setup	34
5.1.1 Node Mobility	34
5.1.2 Types of Links	35
5.1.3 Types of Networks	35
5.1.4 Traffic Models	36
5.1.5 Routing protocols	38
5.1.6 Static Routes	38
5.1.7 Metrics and Parameters	38
5.2 Small Ad Hoc Networks	39

5.2.1	UDP traffic	39
5.2.2	TCP traffic	43
5.3	Large Ad Hoc Networks	45
5.3.1	TCP Traffic	48
6	Conclusions	50
	Bibliography	52
	Vita	54

List of Figures

1.1	Example of an ad hoc wireless network.	2
1.2	One-hop wireless networks.	3
1.3	Mixed wired and wireless networks.	5
2.1	Protocol layer structure.	9
2.2	DCF and PCF. (Taken from [7])	10
2.3	Wireless islands or independent basic service sets (IBSS).	11
2.4	Connected wireless islands (extended service sets, ESS).	11
2.5	CSMA/CA.	12
2.6	Hidden Terminal.	12
2.7	Transmitting a data frame in 802.11	13
2.8	Backoff procedure in IEEE 802.11. (Taken from [7].)	14
3.1	The event driven model and different protocol layers in Glomosim.	20
3.2	The protocol layer structure for wired and wireless transmission.	21
3.3	The structure of network layer and MAC layer for wired transmission.	22
3.4	The structure of MAC layer for wireless transmission.	23
3.5	The structure of radio layer.	24
4.1	Dissemination of routing information in ad hoc wireless networks.	27
4.2	Dissemination of routing information in mixed wired and wireless networks.	27
4.3	Data transmission in ad hoc wireless networks.	29
4.4	Data transmission in mixed wired and wireless networks.	29
5.1	Fifty-node wireless network in a field of 1500m x 1500m.	36
5.2	Fifty nine-node wireless network with 50 mobile and 9 fixed nodes.	37
5.3	Mixed network with 50 mobile nodes and 9 fixed nodes.	37
5.4	Throughputs achieved for CBR traffic on 50/59-node ad hoc networks.	40
5.5	Delivery rate on 50/59-node ad hoc networks.	40
5.6	The number of wireless hops taken by each data packet on 50/59-node ad hoc networks.	40
5.7	Overheads on wireless links achieved for CBR traffic on 50/59-node ad hoc networks.	40
5.8	Average Network Allocation Vector (NAV) on 50/59-node ad hoc networks.	42
5.9	Average broken routes on 50/59-node ad hoc networks.	42
5.10	Average delays achieved for CBR traffic on 50/59-node ad hoc networks.	42
5.11	Average delays (offerloads from 0 to 80 kbps) achieved for CBR traffic on 50/59-node ad hoc networks.	42
5.12	Throughputs achieved for HTTP traffic on 50/59-node ad hoc networks. Each server has one client.	43

5.13	Throughputs achieved for HTTP traffic on 50/59-node ad hoc networks.	43
5.14	Overheads on wireless links achieved for HTTP traffic on 50/59-node ad hoc networks. . . .	44
5.15	Overheads on wireless links achieved for HTTP traffic on 50/59-node ad hoc networks. . . .	44
5.16	Throughputs achieved for FTP traffic on 50/59-node ad hoc networks.	44
5.17	Overheads achieved for FTP traffic on 50/59-node ad hoc networks.	44
5.18	Throughputs achieved for CBR traffic on 1000-node ad hoc networks.	45
5.19	Delivery rates for CBR traffic on 1000-node ad hoc networks.	45
5.20	The number of wireless hops taken by a data packet in 1000-node ad hoc networks.	47
5.21	Overheads on wireless links achieved for CBR traffic on 1000-node ad hoc networks.	47
5.22	Average Network Allocation Vector(NAV) value for various 1000-node ad hoc networks. . .	47
5.23	Average broken routes in CBR simulation on 1000-node ad hoc networks.	47
5.24	Average delays achieved for CBR traffic on 1000-node ad hoc networks.	48
5.25	Average delays (offerloads from 0 to 500 kbps) achieved for CBR traffic on 1000-node ad hoc networks.	48
5.26	Throughputs achieved for HTTP traffic on 1000-node ad hoc networks. Each server has five clients.	49
5.27	Throughputs achieved for HTTP traffic on 1000-node ad hoc networks. Each server has ten clients.	49

Chapter 1

Introduction

The current Internet consisting of primarily wired links, stationary hosts and routers has become the most important and efficient communication tool all over the world today. Many governments and companies have invested thousands of millions of dollars in the research of protocols and routing algorithms for network to design new network equipment and construct Internet infrastructure. Due to these efforts, services that wired networks provide now are highly reliable, span large distances and are inexpensive to use. However, the wired Internet is not suitable for mobile users.

During the past decade, mobile ad hoc networks (MANETs) have become a hot research topic. A MANET is a collection of wireless mobile nodes dynamically forming a temporary network without the use of any existing network infrastructure or centralized administration. MANETs are especially useful in areas where there is little or no wired communication infrastructure or the existing infrastructure is too expensive or inconvenient to use. MANETs are characterized by multi-hop wireless connectivity in a frequently changing network topology. So the research related to ad hoc networks developed quickly in the last few years [20, 28, 3]. An example MANET with 50 nodes is shown in Figure 1.1.

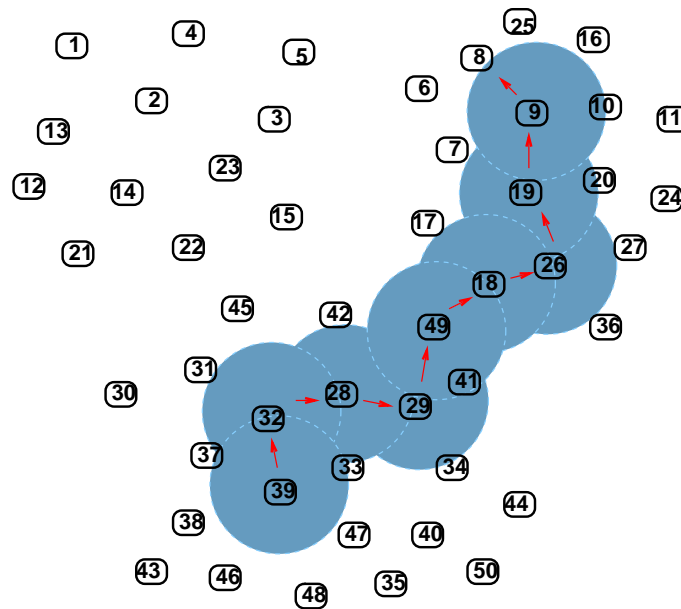

Figure 1.1: Example of an ad hoc wireless network. Numbered rectangular boxes indicate mobile nodes. Shaded circular areas indicate the radio propagation ranges of nodes at their centers. For clarity, the radio ranges for only selected nodes are shown. The sequence of transmissions needed to send a message from node 39 to node 8 is indicated by arrows.

1.1 Next Generation Wireless Networks

Ad hoc wireless networks

An ad hoc wireless network consists of mostly homogeneous wireless links, based on a common medium access control (MAC) standard such as IEEE 802.11 [7]. Each station can be mobile and with only wireless communication capability. Owing to the limited radio propagation range of the wireless devices used, messages among non-neighbor nodes go through multiple intermediate nodes to reach destinations. For example, node 39 transmits a packet through nodes 32, 28, 29, 49, 18, 26, 19 and 9 to reach node 8 as shown in Figure 1.1.

Because of the multi-hop communication, even for short geographical distances, say, 1 km, and random movement of mobile nodes, applications of ad hoc wireless networks are mainly restricted to small wireless “islands.” These wireless islands can be useful for military or limited home use. Bob Metcalfe, the inventor of Ethernet, wrote [(Metcalfe, 1995)] “*Mobile wireless computers are like mobile pipeless bathrooms -*

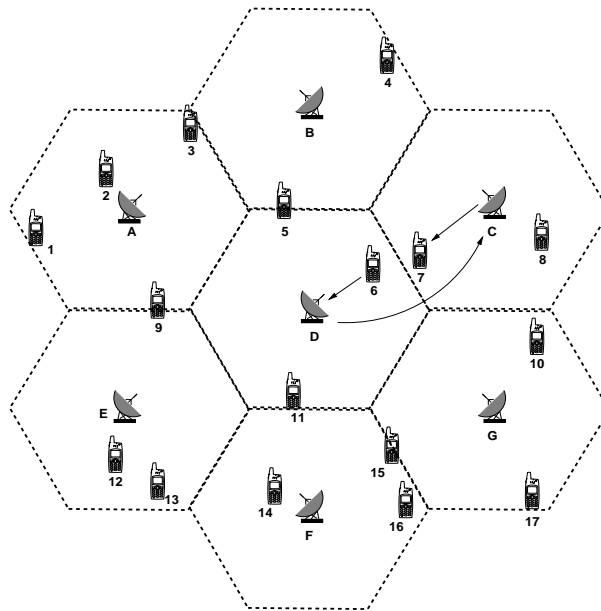

Figure 1.2: One-hop wireless networks. Dotted lines indicate the radio propagation ranges of base stations at center. The sequence of transmission to send a message from cell phone 6 to cell phone 7 is shown with solid arrows.

portapotties. They will be common on vehicles and at construction sites, and rock concerts. My advice is to wire your home and stay there.”

So without the reliability compared a wired network, and access to the Internet, these ad hoc networks are not likely to be useful for general purpose networking.

One-hop wireless networks

One-hop wireless networks are commonly used in recent years. There is only one wireless hop from any mobile node to a fixed station, which is connected to a network infrastructure via wired or microwave links. The typical examples are the cellular networks, shown in Figure 1.2, and the hot spots that provide wireless access for laptops in public places such as airport lounges and campuses.

The first obvious disadvantage of the one hop wireless networks is that each mobile node must be in the radio range of one of the fixed stations. So to provide services, at least one cell phone base station must be used in each cellular area and all these cellular areas must be combined into a seamless coverage. It is

expensive and sometimes impractical to maintain these ideal cellular coverage for large areas.

The second disadvantage is the waste of time, bandwidth and energy. For example, even though cell phones 6 and 7 in Figure 1.2 are in each other's radio propagation range, they still have to transmit messages to base stations D and C. Then D and C complete the path by using an infrastructure connection. With ad hoc networking, however, phones 6 and 7 can communicate directly.

The third disadvantage is the inefficient use of resources. To avoid the "crosstalk", the base station C and D have to use different channels. We can't take advantage of high shared bandwidth and have to assign for each base station individual low bandwidth.

Mixed wired and wireless networks

Given the strengths and weaknesses of ad hoc and one-hop wireless networks, we believe that mixed networks consisting of fixed infrastructure and mobile user nodes are suitable for a medium range network spanning, for example, a metropolitan area; point-to-point wired or wireless links among fixed nodes and wireless links for all nodes can be used for connectivity. These networks take advantage of both reliability and high bandwidth of wired infrastructure backbone and flexibility and low cost of wireless links using ad hoc networking concepts. Because these networks make use of ad hoc networking, there is no need for fixed nodes to cover all the desired area. If a fixed node is unavailable as a neighbor, a mobile node can send its data through other mobile nodes to the destination or to the nearest fixed node. To illustrate our view of mixed networks, we incorporated fixed nodes with point-to-point (p2p) links among them in the ad hoc network example shown earlier. The resulting mixed network is shown in Figure 1.3. For ease of description, (a) we use p2p links and wired links synonymously and (b) wireless links to indicate short-haul wireless channels among nodes.

Let us consider the communication between 39 and 8. In the mixed network, node 39 will transmit messages to the fixed station B in its radio propagation range, and B will forward these messages to its

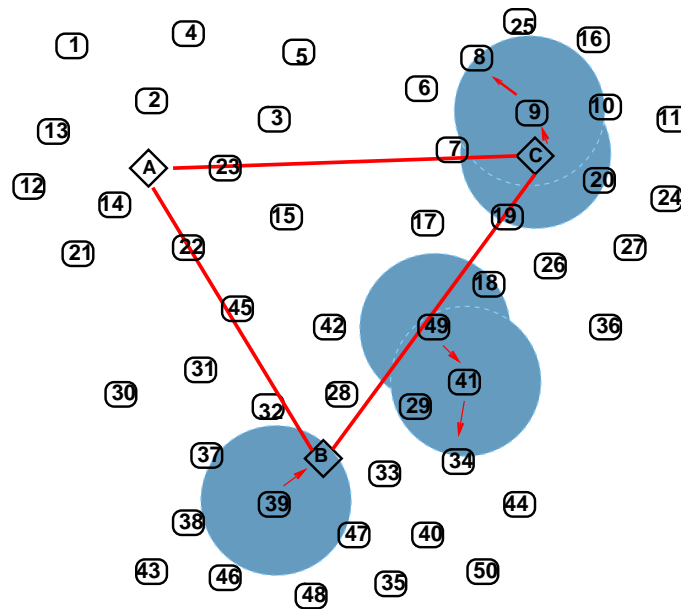

Figure 1.3: Mixed wired and wireless networks. Rectangular boxes with rounded corners and numbers inside indicate mobile STAs. Diamond shape boxes with letters inside indicate fixed infrastructure nodes. Shaded circles indicate the radio propagation ranges of nodes at center. Solid lines AB, AC and BC indicate p2p links such as wired links or long-haul wireless links. All nodes are capable of using a short-haul wireless technology such as 802.16. Two sequences of transmissions are indicated. The wireless links used are indicated by shaded circles. One is sending a message from node 39 to node 8 which use p2p links between fixed infrastructure nodes B and C. The other is sending a message from node 49 to node 34 which use only ad hoc wireless links.

wired neighbor C. Then, these messages pass an intermediate node 9 and reach its destination node 8. This long distance transmission involved both fixed infrastructure nodes and mobile wireless nodes. At the same time node 49 transmits some message via wireless neighbors 41 to reach node 34. This short distance transmission only involved wireless hops locally. These two transmissions don't interfere with each other. Such parallel use of wireless channels is greatly improved in mixed networks.

1.2 Designing and Using Mixed Networks

With the advent of new technologies, it is feasible to design the proposed mixed networks. The IEEE 802.11 [7] is a popular MAC protocol for ad hoc wireless networks. With a radio range of up to 376 m, the 802.11 is a short haul wireless link protocol. The fixed infrastructure nodes are also not difficult to set up. They can be already existing fixed nodes (access points or base stations, for example) connected via

p2p links. These p2p links can be wired links or long haul wireless links. For example, the new IEEE 802.16 [9] provides a long haul (less than 10 km) wireless link protocol. Recently, a few researchers have started investigating the benefits of mixed networks [2, 21, 25].

However, there are three main challenges to using these mixed networks. First, there are no efficient routing protocols to take advantage of both reliability and flexibility of mixed types of links. Second, many security issues need to be solved. Third, current applications may need to be modified since the bandwidth and quality of mixed networks may not be as good as wired networks.

1.3 Contributions of This Thesis

Our focus is on designing a routing algorithm for mixed wired and wireless networks. The current Internet routing algorithms such as Routing Information Protocol (RIP) [18], Open Shortest Path First (OSPF) [26] do not work well for wireless networks, while the zone routing protocol (ZRP) for ad hoc networks [17], the cluster based routing protocol (CBRP) for ad hoc networks [19], the core extraction distributed ad hoc routing (CEDAR) [15], associativity based routing protocol (ABR) for ad hoc networks [31], highly dynamic destination-sequenced distance vector (DSDV) for mobile computers [27], Ad hoc On demand Distance Vector (AODV) [28], Dynamic Source Routing (DSR) [20] and Adaptive Distance Vector (ADV) [3] focus only on ad hoc wireless networks and do not take advantage of p2p links. The performance analysis and comparison on several routing algorithms for ad hoc network can be found in [24, 30, 4, 14]

In this thesis, we present a new routing algorithm ADV Static (ADVS) routing algorithm, which is based on ADV [3]. It can use specified static routes and discover and maintain any other needed routes dynamically using ad hoc routing concepts. It is especially suitable for metropolitan area networks with mixed wired and wireless links, which usually have some fixed base stations connected to the backbone of the Internet infrastructure. ADVS routing algorithm takes into account the performance characteristics such as bandwidth, delay and reliability of wired and wireless links and uses the existing wired network resources as much as possible.

Another contribution of this thesis is implementation of ADVS in a commonly used Glomosim simulator and enhancing Glomosim to simulate mixed networks.

To evaluate the performance benefits of mixed networks over ad hoc wireless networks, we simulated both types of networks with ADVS as the routing protocol. We consider both UDP and TCP traffic patterns. In all cases, mixed networks provide better throughput and packet delays. A few point to point links added to an otherwise ad hoc network can double the throughput and halve the packet delays even when point to point links and wireless links have the same bandwidth.

1.4 Organization

The rest of the thesis is organized as follows. Chapter 2 gives the background on the commonly used MAC and routing protocols for MANETS. Chapter 3 introduces the Glomosim simulator and describes our modifications to the same to facilitate simulation of mixed networks. Chapter 4 describes the ADV Static (ADVS) routing protocol that we have developed and discusses the related design and implementation issues. Chapter 5 presents a comparison of mixed and ad hoc networks' performance for various types of network traffic and different network sizes. Chapter 6 concludes the thesis.

Chapter 2

Background

We first give an overview of the MAC (medium access control) protocol used to design MANETs. Next, we describe a few commonly used current routing algorithms for ad hoc networks. First, we define some commonly used acronyms.

AP: Access point

BSS: Basic service set

CSMA: Carrier sense multiple access

CSMA/CA: Carrier sense multiple access/collision avoidance

CSMA/CD: Carrier sense multiple access/collision detection

DCF: Distribution coordination function

DIFS: DCF interframe space

DS: Distribution system

DSS: Distribution system service

EIFS: Extended interframe space

ESS: Extended service set

IBSS: Independent basic service set

LLC: Logical link control

MAC: Media access control

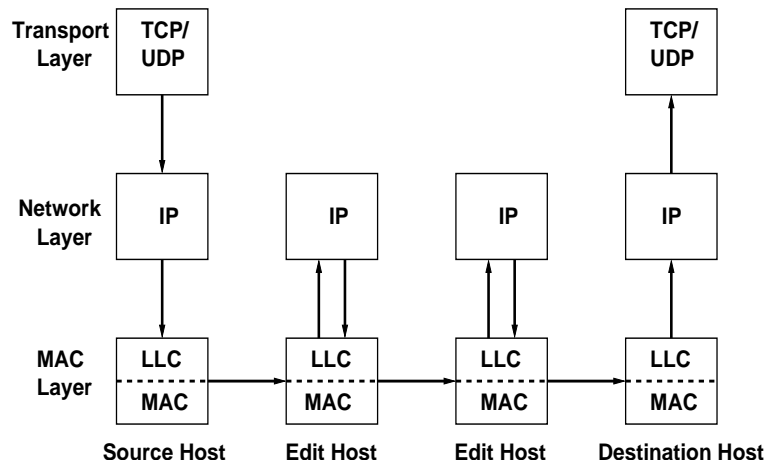

Figure 2.1: Protocol layer structure.

NAV: Network allocation vector

PCF: Point coordination function

PC: Point coordinator

PHY: Physical layer

SIFS: Short interframe space

STA: Station

The network protocol layer structure is shown in Figure 2.1. TCP and UDP are the commonly used transport layer protocols. IP is the basic protocol in network layer. All routing protocols reside in network layer and this is an active research area. There are also various standards for MAC layer protocols such as Bluetooth [8], ultrawide band, [16], IEEE's 802.11 [7], 802.16 [9] and 802.20 [10]. Bluetooth and ultrawide band [16] are suitable for personal area networks since their communication range is often 10m or less. 802.16 and 802.20 are useful for long-range wireless protocols. The 802.11 has a radio range of 100s of meters, available inexpensively, and is suitable for battery powered devices. So it is used on the wireless link protocol in ad hoc network designs. Since our research is based on IEEE 802.11, we will describe it next.

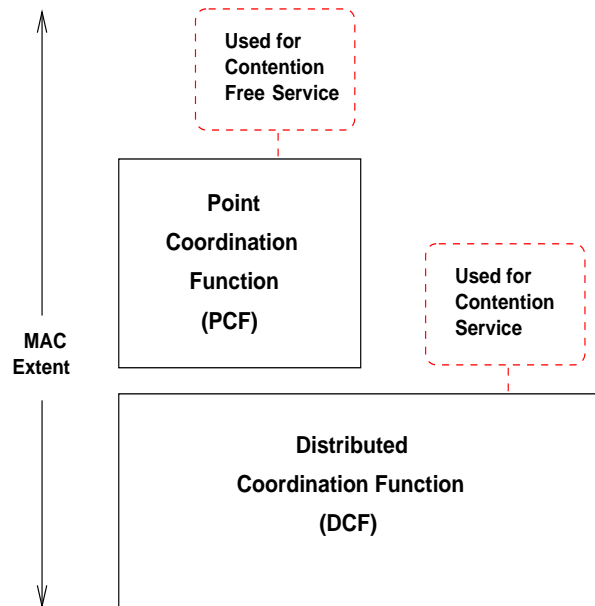

Figure 2.2: DCF and PCF. (Taken from [7])

2.1 Overview of IEEE 802.11 MAC layer

The 802.11 MAC architecture for MANETs can be described using the block diagram shown in Figure 2.2. It includes two modes of operation: distributed coordination function (DCF) and point coordination function (PCF). DCF is a fundamental medium access protocol that allows for automatic medium sharing between compatible physical channels (PHYs). It can be used in two situations: first, in an independent basic service set (IBSS) which operates like an isolated network, as shown in Figure 2.3; second, in an extended service set (ESS), which is composed of multiple basic service sets (BSSs) connected through a distribution system (DS) as shown in Figure 2.4. In each BSS, one of the nodes or stations (STAs) acts as an access point (AP) that provides access to the DS. The DS is used to provide connectivity among STAs not in a single BSS, which forms the basis for distributed services. More importantly, APs can act as infrastructure nodes.

In DCF, since all nodes compete for the medium, channel access mechanisms such as CSMA/CA with random back-offs are used to handle the contention. We will describe these techniques in detail later.

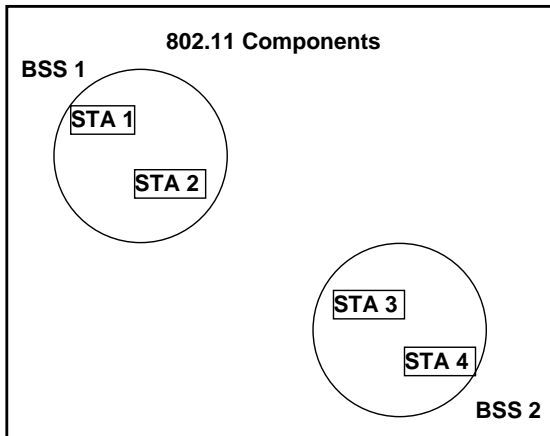

Figure 2.3: Wireless islands or independent basic service sets (IBSS).

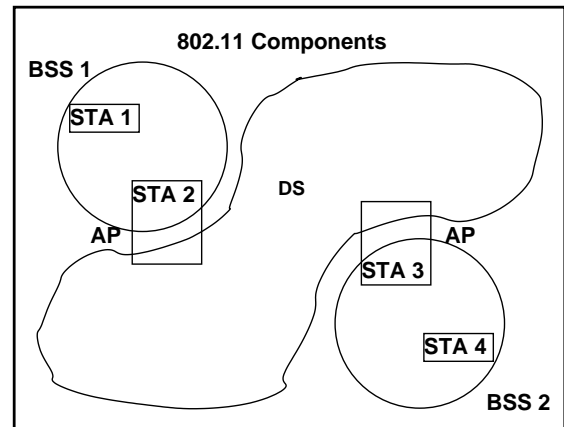

Figure 2.4: Connected wireless islands (extended service sets, ESS).

PCF is another access method that provides contention-free frame transfer. One of the STAs acts as a point coordinator (PC) to determine which STA currently has the right to transmit. The operation is based on the concept of polling. The PC performs the role of the polling master and the other stations as the slaves. The 802.11 standard requires that the PC in PCF model must be the AP connecting to the DS in ESS. So, PCF can only be used within infrastructure network configurations as shown in Figure 2.4. Hot spots in airport lounges are examples of this mode of operation.

Since we are interested in ad hoc networking among mobile nodes, DCF is more appropriate for our work on routing protocols.

2.1.1 Carrier Sense Multiple Access (CSMA) Protocol

CSMA is a MAC protocol in which all stations listen to channel before transmitting data [29]. If a transmitting station can detect collisions even before its transmission is completed, then it is CSMA with collision detection (CSMA/CD) protocol. The Ethernet uses CSMA/CD MAC protocol, which is defined in IEEE 802.3 for wired networks [6]. However, due to signal fading and attenuation, collisions on a wireless channel may not be detected by a transmitting node in wireless networks. As shown in Figure 2.5, A and C can communicate with a common node B but they can't hear each other. Even when A and C are in each

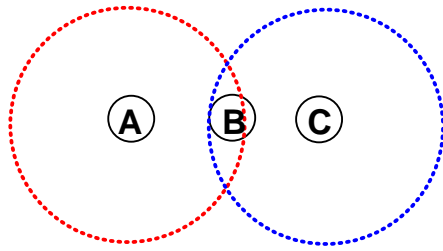

Figure 2.5: CSMA/CA. Dotted circles indicate the radio propagation ranges of nodes at center.

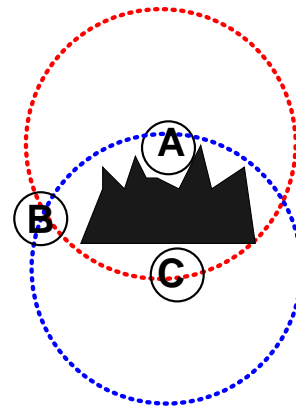

Figure 2.6: Hidden Terminal. Dotted circles indicate the radio propagation ranges of nodes at center. The solid black shape between node A and C is obstacle.

other's radio propagation range, they might not detect each other's transmission because of the physical obstruction as shown in Figure 2.6. In both situations, undetectable collisions can result if both two stations believe the channel to be idle and try to transmit data to B simultaneously.

So the IEEE 802.11 uses CSMA/CA techniques to solve this problem for wireless networks. The CSMA with collision avoidance (CSMA/CA) protocols attempt to prevent a station from transmitting simultaneously with other stations within its transmitting range by requiring each mobile host to ensure that the channel is idle before transmitting. It uses the Request-to-send/Clear-to-send (RTS/CTS) exchange to reserve the wireless channel for transmission of a data packet. The process is as follows: (a) The sender sends a short control packet, denoted RTS, to notify its neighbors including its intended receiver that it has data to send. (b) If the receiver successfully received the sender's RTS, it sends a short control packet, denoted CTS, to notify its neighbors of pending channel use and to indicate to a sender that it is ready to receive data. (c) The sender sends the data if it successfully receives CTS from receiver. (d) The receiver sends a short control packet, ACK, if it receives the data successfully. The RTS/CTS exchange process is illustrated in Figure 2.7. Both RTS and CTS frames contain a Duration/ID field that defines the period of time that the medium is reserved for this transmission sequence. This duration field is used by the neighbor stations to set up virtual carrier sensing. Each node maintains the network allocation vector (NAV), a record of

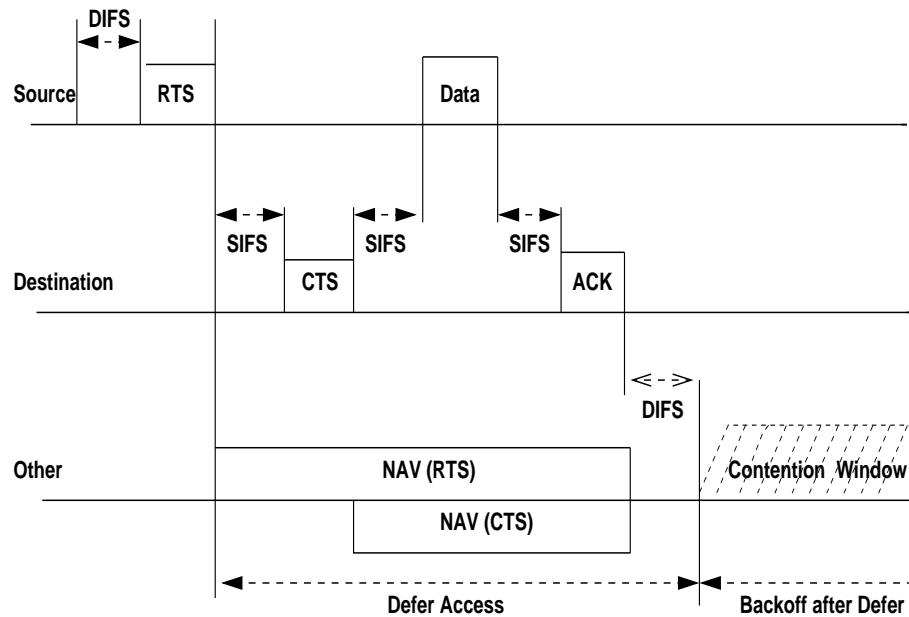

Figure 2.7: Transmitting a data frame in 802.11. SIFS and DIFS are interframe spacings between transmissions. (Taken from [7].)

future traffic on the medium based on the duration information that is announced in RTS/CTS frames prior to the actual exchange of data. 802.11 uses both virtual carrier sense mechanism (determined by NAV) and physical carrier sense mechanism (based on the signal or noise level on the channel) to determine whether a channel is busy.

Broadcast packets are sent only when the physical and virtual carrier senses indicate that the medium is clear but they are not preceded by an RTS/CTS and are not acknowledged by their recipients.

The main advantage of the RTS/CTS exchange is that it performs fast collision interference and a transmission path check. If the corresponding CTS is not detected by the STA originating an RTS, the originating STA may repeat the process more quickly than if the long data frame had been transmitted and a return ACK frame had not been detected.

The RTS/CTS exchange reserves the wireless channel for transmission of a data packet. So in the period of the current transmission, all other STAs which can receive the RTS/CTS will think that the channel is

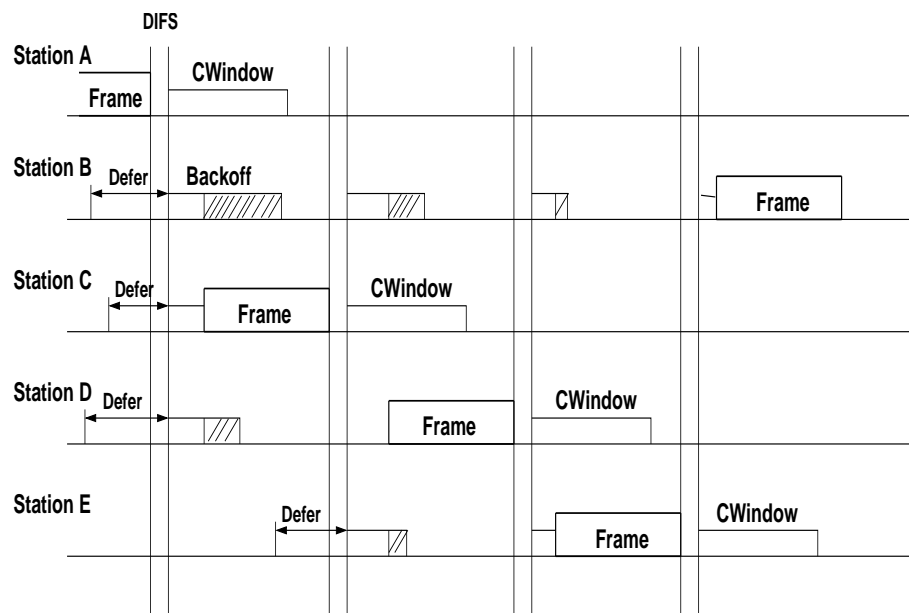

Figure 2.8: Backoff procedure in IEEE 802.11. (Taken from [7].)

busy and execute a random back-off procedure if they also have data packets to send. To begin the back-off procedure, the STA will set its backoff timer to a random back-off time. The backoff timer is counted down when the channel is idle (after a DCF interframe space (DIFS) period during if the medium is determined to be idle or the last frame is received correctly or after extended interframe space (EIFS) during if the medium is determined to be idle or the last frame transmission was incorrect).

Randomized backoffs minimize collisions during contention between multiple STAs that have been deferring to the same event. When multiple STAs are deferring and go into random back-off, then the STA selecting the smallest back-off time will win the contention. This process is as shown in Figure 2.8.

2.2 Routing Algorithms for Ad Hoc Networks

This section will focus on the routing algorithms developed for mobile ad hoc networks. In recent years, there are several routing algorithms designed for wireless networks. In general, they can be put into two different groups: on-demand and proactive. The on-demand routing algorithms build or maintain only the routing paths that have changed and are needed to send the data packets currently in the network. The

proactive routing algorithms disseminate routing information among all the nodes in the network irrespective of the need for any such route. AODV [28] and DSR [20] belong to the first group. ADV [3] is a proactive technique but exhibits some on-demand characteristics: only the existing routes are maintained and new routes are discovered on demand.

Ad hoc On-demand Distance Vector (AODV): The Ad hoc On-demand Distance Vector routing protocol enables multi-hop routing between participating mobile nodes wishing to establish and maintain an ad hoc network. AODV is based on the distance vector algorithm, developed for the traditional wired network, and treats each mobile host as a router. The basic property of distance vector routing algorithm is proactive: each node broadcasts routing updates to its neighbors periodically or more frequently even when there is no change in routes. However, AODV discovers a route only when needed and does not require nodes to maintain routes to destinations that are not actively used in communications. This makes AODV an on demand or reactive routing protocol. The needed routes are discovered using network-wide flooding of control packets (denoted RREQs) and the replies (denoted RREPs) by target nodes. The routes discovered are maintained in a routing table similar to that used in distance vector routing algorithm.

Dynamic Source Routing (DSR): DSR shares AODV's on-demand characteristics in that it discovers routes via a similar route discovery process. However, it adopts a different mechanism to store or represent routes. A routing entry in DSR contains all the intermediate nodes to be visited by a packet rather than just the next hop information maintained in AODV. A source puts the entire routing path in the data packet header, and the packet is sent through the intermediate nodes specified in its header. The routing decision is therefore made at the source. The advantage with this approach is that it is very easy to avoid routing loops. Also the intermediate nodes need not keep routing information because the path is explicitly specified in the data packet. The disadvantage is that packet headers are longer and of variable size.

Adaptive Distance Vector (ADV): The adaptive distance vector is a combination of proactive and on-demand techniques. ADV shows proactive characteristics by disseminating routing information among all

neighbor nodes using triggered or periodic updates like in a distance vector routing protocol. It varies the frequency and the size of the routing updates based on the network conditions.

Unlike some DV, distance vector, protocols which advertise and maintain routes for all nodes in the network, ADV maintains routes to only active receivers to reduce the number of entries advertised. A node is an active receiver if it is the receiver of any currently active connection. At the beginning of a new connection, the source broadcasts (floods) network-wide with an *Initconnection* advertising that its destination node is an active receiver. A node that receives *Initconnection* packet marks the target of *Initconnection* as active receiver and start advertising the routes to the receiver in future updates. The target destination node upon receiving the *Initconnection* packet responds, if it is not marked as an active receiver already, by broadcasting network-wide with a *Receiveralert* packet. Unlike the route discovery process in the on-demand protocols, the connection-initiation process in ADV is mainly intended to advertise a destination as an active receiver, though as a side effect the routes to the destination are also known to all nodes initially. When a node receives such a control packet it creates an reverse path entry to the source of the control packet in its routing table if it doesn't have a entry to the source already. After this process, routes to the receiver are maintained using routing updates.

ADV adaptively triggers partial and full updates such that periodic full updates are obviated. In this protocol, a node triggers an update under three conditions: (a) if it has some buffered data packets due to lack of routes, (b) if one or more of its neighbors make a request for fresh routes, and (c) if it is a forwarding node that intends to advertise any fresh route to the destination so as to keep the route fresh. The impact of all the events that require a triggered update is quantified and captured in a variable called trigger meter. Each node keeps track of its own trigger meter. ADV adjusts the trigger meter based on the value of several other parameters associated with the three conditions mentioned above. For example, each node categorizes the network as HIGH_SPEED or LOW_SPEED based on the neighborhood changes perceived by the node. If the number of neighbor changes is high (exceeds a certain value), then the node speed is high. Another parameter is buffer threshold. When a new packet is buffered for lack of a route, a check is made if the

number of packets already buffered exceeds a preset number, called buffer threshold. If it exceeds, the trigger meter is incremented in order to force an update. The trigger threshold is used to decide when an update needs to be triggered. The trigger meter is reset to zero after scheduling any update. This trigger threshold is changed dynamically based on the recent history of trigger meter values at the time of previous partial updates. More detailed description of ADV can be found in [3, 22, 11].

Chapter 3

Glomosim Simulator

GlomoSim is a scalable wireless and wired network simulator that has been developed by Bagrodia *et al.* at UCLA [1]. It is implemented in Pasec language, suitable for parallel discrete-event simulations. The current version of Glomosim, 2.03, has several built-in ad hoc routing protocols and an accurate 802.11 MAC protocol. In addition, Glomosim can be used to simulate networks with point-to-point links if all routes are specified by the user. If all routes are static, then it is feasible to simulate mixed networks. However, Glomosim can not simulate networks with mixed p2p and wireless links if one or more routes are incompletely specified. So Glomosim needs to be enhanced to simulate the proposed mixed networks in which some routes are static and the rest change dynamically and need to be discovered by an ad hoc routing protocol.

Glomosim use a layered approach based on the open system interconnect (OSI) network architecture [29]. Standard APIs are used for interaction between different simulation layers. The models currently available in Glomosim includes:

Application: TCPLIB (telnet, ftp), CBR (constant bit rate traffic), Replicated file system, HTTP

Transport: TCP (FreeBSD), UDP, NS TCP (Tahoe) and others

Unicast Routing Protocols: AODV, DSR, Fisheye, Flooding

MAC layer: CSMA, FAMA, MACA, IEEE 802.11

Radio: Radio with and without capture capability

Mobility: Random waypoint, Random drunken, Group mobility

Glomosim is written in Parsec (a C based parallel simulation language) and includes a visualization tool named JavaGui written in JAVA to view positions of nodes and connections among them during simulation. We describe below a couple of modifications we made to the Glomosim simulator to facilitate simulation and evaluation of mixed networks.

3.1 Passing information across nodes

ADVS emphasizes stable routes. Since wired links are considered to be much more stable than wireless links, it is necessary to keep track of wireless hops and wired hops in a route. Also we need to keep track of wired and wireless hops taken by a packet. This is easy to ensure for the control packets managed by the routing protocol. We simply add extra variables and perform the needed updates at the routing layer. It is much harder for data packets since this will require changes to application, or Ip header. To avoid this, we modified the basic message structure used by Glomosim with *WiredLinkCount* variable to keep track of wired hops taken by any packet (control or data) sent over multiple hops. This new information must be preserved when a packet is broadcasted at MAC level by a node to its neighbors, which is simulated by duplicating the packet and providing one copy to each of the neighbors. Since the new information is added by us, we needed go through Glomosim MAC implementation and add extra code for copying the new information. In order to explain our modifications, which can also be used for additional statistics gathering, we introduce the structure of Glomosim.

Glomosim has a data structure named *GlomoPartition* which contains the list of all nodes in this partition. Glomosim is event-driven. The events are maintained in a heap structure. *GlomoPartition* keeps a heap for all the nodes in the partition, so that we can easily retrieve the earliest event in this partition. When any node creates a event, a message is formatted and inserted into the heap. The main program of Glomosim takes the lowest time stamped event from the heap and processes it.

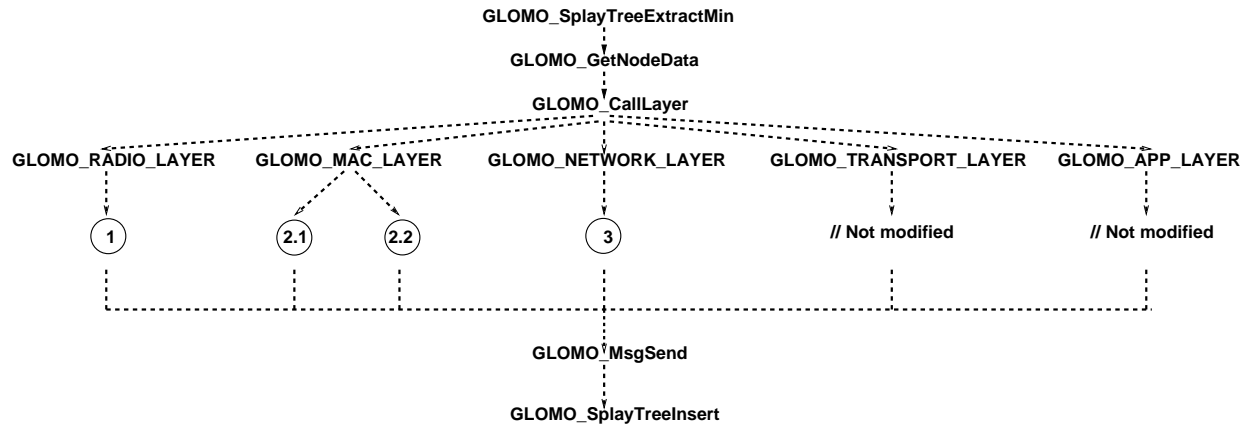

Figure 3.1: The event driven model and different protocol layers in Glomosim.

The basic structure of Glomosim is shown in Figure 3.1. The function *GLOMO_SplayTreeExtractMin* extracts the message from the heap. Then *GLOMO_GetNodeData* will decide how to handle the message. If it is a normal packet, it will be passed to *GLOMO_CallLayer* which will call the appropriate layer to handle the message. These layers include radio layer, MAC layer, network layer, transport layer and application layer. Since our research doesn't modify transport and application layers, we do not describe them in detail here. We will describe the radio layer, MAC layer and network layer in detail next.

Recall the Protocol layer structure that showed in Figure 2.1. Glomosim separates the handling of wireless and wired transmission events. To simulate a transmission over a wired link, Glomosim combines the processing between network and MAC layers in one function. This is represented as one branch in Figure 3.2. To simulate a transmission via a wireless link, Glomosim has two branches: One handles messages that go down from network layer to MAC layer and then down to radio layer. The other handles messages that go up from radio layer to MAC layer and then up to network layer (see Figure 3.2).

When the network layer receives a packet from transport layer or when the MAC layer receives a packet via wired links, the *GLOMO_NETWORK_LAYER* or the *WiredLinkLayer* of *GLOMO_MAC_LAYER*, respectively, are called. We show in Figure 3.3 the details of branches numbered 2.2 and 3 in Figure 3.1. There are two types of incoming packets. First, if the node is the destination of the packet, the function *ProcessPack-*

Protocol Layer Structure for Wired Transmission

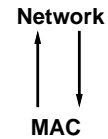

Protocol Layer Structure for Wireless Transmission



Figure 3.2: The protocol layer structure for wired and wireless transmission.

etForMeFromMac is invoked, MAC layer passes the packet up to network layer and transport layer. Second, if the node is an intermediate node on the route to packet's destination, the function *ProcessPacketForAnotherFromMac* is invoked, and Glomosim uses the routing algorithm in network layer to find next hop for the packet and sends it via either wired interface or wireless interface of MAC layer. It is noteworthy that the function *NetworkSendPacketToMacLayer* inserts the packet in the queue between network layer and MAC layer. If the packet will go out via wired interface, the function *WiredLinkNetworkLayerHasPacketToSend* will dequeue the packet and sends it to the next node. This ensures that *wiredLinkCount* field is correctly maintained as the packet progresses.

GLOMO_NETWORK_Layer branch is quite similar to that for *ProcessPacketForAnotherFromMac*. The only difference is that the packet comes from the transport layer within the node.

When MAC layer receives a packet via wireless links, *Mac802_11Layer* of *GLOMO_MAC_LAYER* is called. We show in Figure 3.4 the details of the branch with number 2.1 in a cycle in Figure 3.1. After a chain of functions, it finally generates the *GLOMO_RADIO_StartPropagation* event to invoke the radio

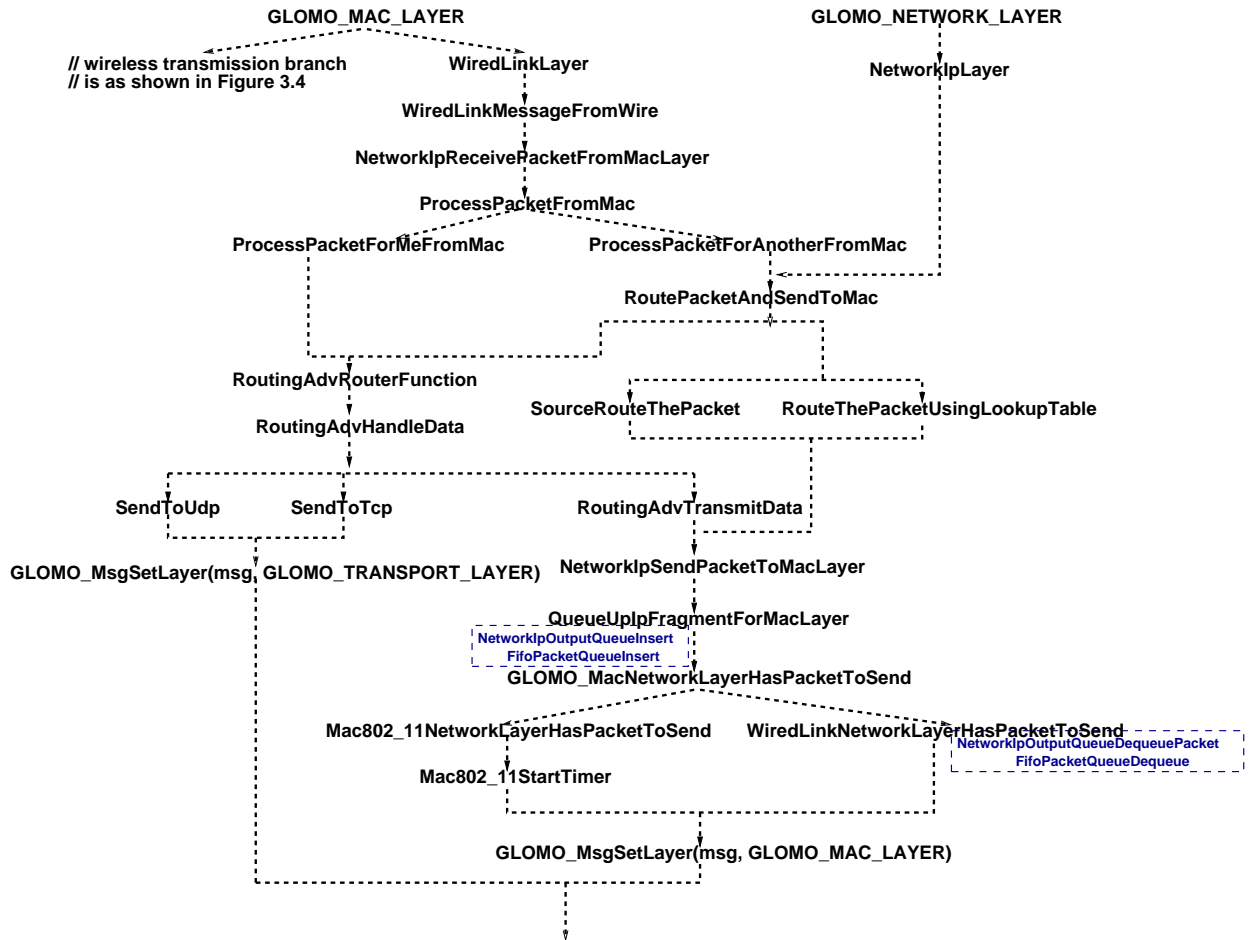

Figure 3.3: The structure of network layer and MAC layer for wired transmission. The details of branches with number 2.2 in a cycle and the number 3 in a cycle in Figure 3.1 is entailed in this figure.

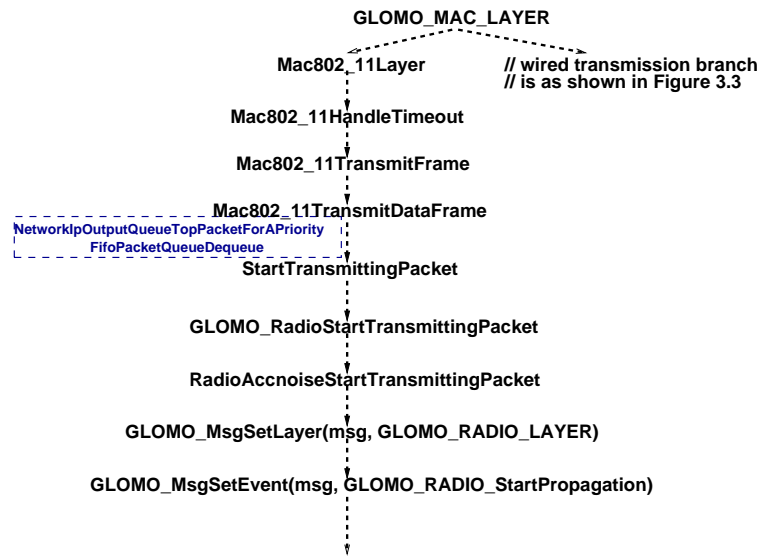

Figure 3.4: The structure of MAC layer for wireless transmission. This illustrates the processing done in branches 2.2 and 3 in Figure 3.1

layer, which we explain below. In the function *Mac802_11TransmitDataFrame*, the Glomosim dequeues the packet stored in the queue between network layer and MAC layer. Then it allocates space for the packet to be passed to the radio layer and copies the appropriate fields of the old packet into the new packet. So, to pass the *wiredLinkCount* information, we added code to copy this field from old packet to each new packet created.

The ability to keep certain book-keeping information with the packet transmitted is also useful for gathering other statistics such as packet delay at routing layer. (Glomosim application layer keeps track of packet delay at the application level, but it is cumbersome to use it and analyze it at the routing layer level.)

When the radio layer receives the *GLOMO_RADIO_StartPropagation* event, *GLOMO_RADIO_LAYER* is called. We show in Figure 3.5 the detail of branch 1 indicated in Figure 3.1. First, *GLOMO_RADIO_LAYER* generates a *MSG_RADIO_FromChannelBegin* event to notify other nodes in its radio propagation range including the destination node. Second, after it finished the transmission, it generates *MSG_RADIO_SwitchToIdle* event to report the status to MAC layer. The handling of *MSG_RADIO_FromChannelBegin* will finally generate the *MSG_RADIO_FromChannelEnd* event and the function *GLOMO_MacReceivePacketFromRadio* will

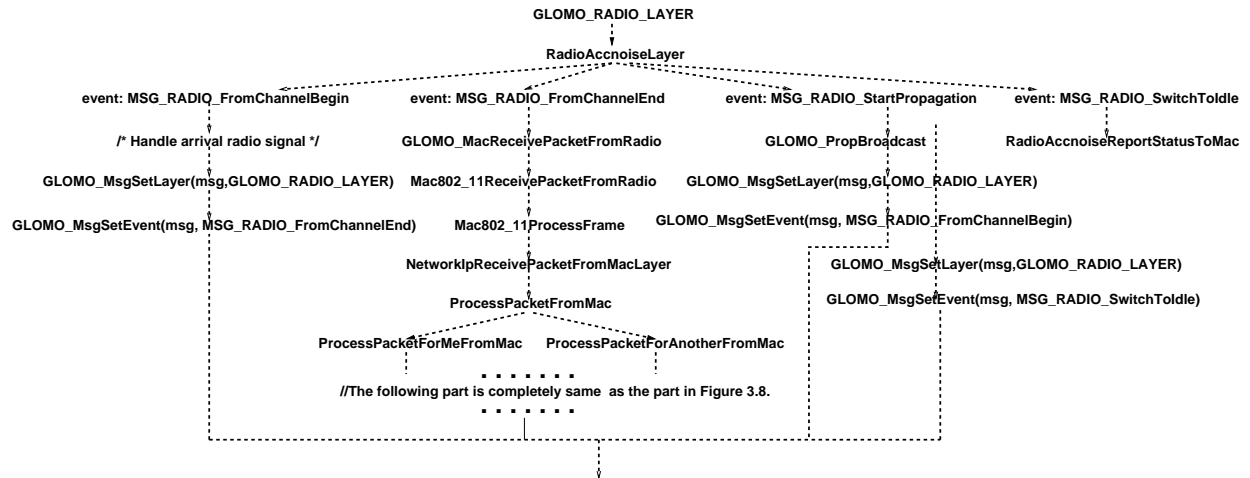

Figure 3.5: The structure of radio layer. This illustrates the processing done in branches 2.1 in Figure 3.1 be called to hand the packet up to MAC layer and upper network layer. The part we omitted in the figure here is the same as that shown in Figure 3.3.

3.2 Simulating fixed and mobile nodes together

The behavior of each node in the simulation is determined by two factors. One is the mobility model and another is the distribution model of initial positions.

To simulate our hybrid networks, we need some nodes to be fixed base stations and other nodes as mobile users. In addition, we would like to have the ability to place fixed nodes at certain locations, while the mobile nodes may be randomly placed based on a random distribution function. (Different scenarios can be created by keeping everything the same and changing the seed for the random number generator used for node placement.) But Glomosim doesn't provide such mixed network environments. So we modified following files to achieve this goal.

We explain the modification for mobility model first. In the file *api.h*, we add a new variable *fixed* to the structure *GlomoNode* to indicate whether this node is the fixed node or a mobile one. Glomosim will read all parameters such as the number of nodes in the scenario from an input file named *config.in* before

it starts the simulation. This field is initialized to be 0 for all nodes in the function *driver* in *driver.pc*. The information of all fixed nodes is given in the file *NODE-PLACEMENT-FILE*, which is specified in the parameter file *config.in*. In the file *nodes.pc*, the function *DriverGenerateInputNodes*, reads the file *NODE-PLACEMENT-FILE* and sets the variable *fixed* to be 1 for the specified fixed nodes.

With the variable *fixed* set correctly, we just need to design different action for fixed nodes and mobile nodes in the function *GLOMO_MobilityRandomWaypointWrap* in *mobility_wrap.pc*. (We modified the builtin node mobility model random waypoint to avoid clustering of nodes unnecessarily. We call the new model random waypoint with wraparound, which is explained in Chapter 5.) This function determine the new position of a node once in every short interval based on node mobility. So for fixed nodes, whose *fixed* value is 1, we always make the new position equal to the original position. The movement of mobile nodes are simulated exactly as in a completely ad hoc network.

The modification of distribution model of initial positions is related with the *NODE-PLACEMENT* parameter in *config.in*. Glomosim has two models: *RANDOM* and *UNIFORM*. To accommodate mixed networks, we added two new models: *FIXED-RANDOM* and *FIXED-UNIFORM*. Then in the function *driver* in *driver.pc*, we add two cases to handle the *FIXED-RANDOM* and *FIXED-UNIFORM*. We still use the function *DriverGenerateRandomNodes* to generate random distribution model or use the function *DriverGenerateUniformNodes* to generate uniform distribution model for all nodes. Then we call the function *GLOMO_ReadString* to read the designated positions for fixed nodes stored in *NODE-PLACEMENT-FILE*. Then we replace the current positions of the fixed nodes by these designated positions.

Thus we modified the simulator to construct the mixed wired and wireless networks. To be able to simulate large realistic mixed networks, we need a routing algorithm that can learn routes dynamically while preserving any supplied static routes. This is described in the next chapter.

Chapter 4

A Routing Algorithm for Mixed Wired and Wireless Networks

In this chapter, we describe a routing protocol for the hybrid network with both wired and wireless capability, called ADV Static (ADVS). ADVS is based on the Adaptive Distance Vector (ADV), described in Chapter 2, and behaves like ADV for networks with only wireless links, but can utilize point-to-point links in mixed networks to improve throughput and routing stability. In addition it will preserve any static routes specified. We use point to point links and wired links synonymously for easier description of the protocol.

4.1 ADV Static (ADVS) Routing Algorithm

ADVS is an enhanced version of the ad hoc network routing protocol ADV described in Chapter 2. So, ADVS uses the control packets such as InitConnection and ReceiveAlert to learn new routes and routing updates to disseminate and maintain routes. The difference is the additional logic to take advantage of wired links among fixed nodes. In ADVS, these control packets are broadcasted via wireless interface to inform wireless neighbors and unicasted via wired interfaces to inform all wired neighbors. ADVS routes the data packets the same way as ADV does. But besides considering the sequence number and cost metric of a routing entry, ADVS uses the number of wired links in selecting routes. Thus ADVS tends to select routes that have fewer route breaks. In addition, mixed networks with ADVS can provide the following advantages over ad hoc networks.

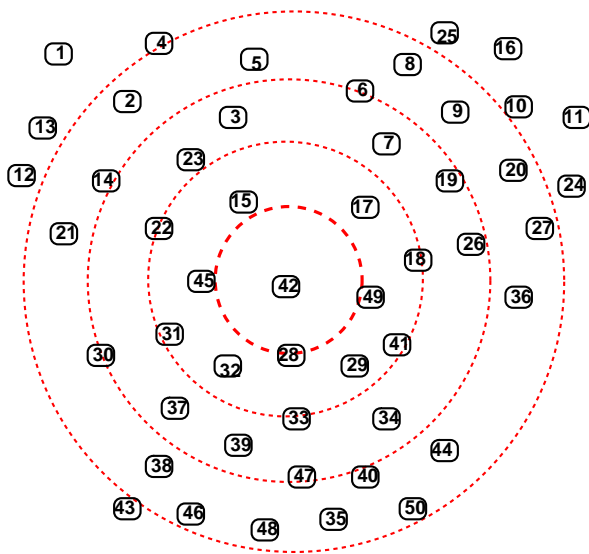

Figure 4.1: Dissemination of routing information in ad hoc wireless networks. The sequence of dotted circles from small to big indicates the propagation of routing information from the source node 42 through whole networks. Node 42 is the center of all dotted circles and the process is like a ripple.

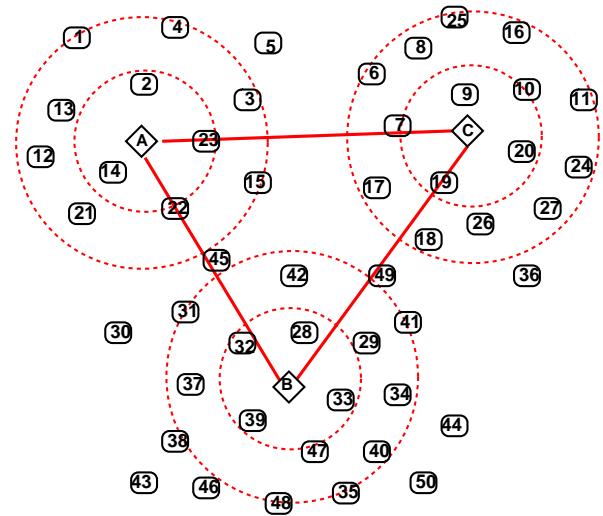

Figure 4.2: Dissemination of routing information in mixed wired and wireless networks. After the infrastructure node B gets the routing information from source 42, it transmits the same via p2p links to A and C. Then A, B and C act as new sources of the routing information besides the original source node 42. The sequence of dotted circles from small to big indicates the process of transmission of routing information from multiple source nodes A, B and C through whole networks. This process is like having several simultaneous smaller ripples.

Accelerate the dissemination of routing information

In ADV algorithm, the source node uses broadcasts to find routes and disseminate routing tables. Each node that receives the information re-broadcasts it to its neighbors if the information is new. If we view the source of the control packet at the center of co-centric rings, the dissemination of routing information is like a ripple as shown in Figure 4.1.

In ADVS, a node sends control packets via wired interfaces by unicast before broadcasting it via the wireless interface. Each wired neighbor will transmit the information to its wired and wireless neighbors. So, the dissemination of routing information via wireless channels can be viewed as many ripples with different centers as shown in Figure 4.2.

By placing infrastructure nodes without overlap in their radio ranges, we can accelerate the dissemination of the routing information. Usually the bandwidth of a wired link (campus-wide: 100-1000 Mb/s, City-wide: 45-155 Mb/s) is much higher than the bandwidth of a wireless link (11-54Mb/s) and they are normally full-duplexed. So a broadcast can be distributed among fixed nodes much more quickly compared to broadcasts on a wireless channel. The transmission process in ADVS is like starting multiple ripples instead of the only one increasingly larger ripples in ADV.

Decrease the delay of transmission of data

ADVS can improve packet delays significantly. We show the process of data transmission with ADV algorithm in Figure 4.3. Assume that node 39 is trying to communicate with node 8, the transmission depends on the intermediate nodes 32, 28, 29, 49, 13, 26, 19, 9 on the route. Recall the CSMA/CA MAC protocol described in Chapter 2. If any other node which is in current node's or its next hop's radio propagation range is transmitting, the current node has to wait. With more wireless nodes involved in the route, this can cause transmission delays and reduced bandwidth to the nodes using of the wireless channel.

Usually the delay to a wired neighbor is much lower than the delay to a wireless neighbor since the bandwidth of a wired link is much higher than the bandwidth of a wireless link and there is no contention on point to point links. So ADVS is designed to give higher priority to p2p links in selecting routes. We illustrate this using an example illustrated in Figure 4.3 and Figure 4.4. In the example scenario, where node 39 is trying to communicate with node 8, the delivery of a data packet in the mixed network depends nodes B, C and 9 on the route in order. Since it involves only three wireless transmissions, the delay to send packets to destinations is decreased, probably significantly.

Efficient use of wireless bandwidth

ADVS makes more simultaneous transmissions feasible. Due to the CSMA/CA MAC protocol, the transmission of one node on a wireless channel prevents others' transmissions which are in the radio propagation range of this node. For example, in Figure 4.3, when node 28 is transmitting to 29, node 32, 33, 42 have

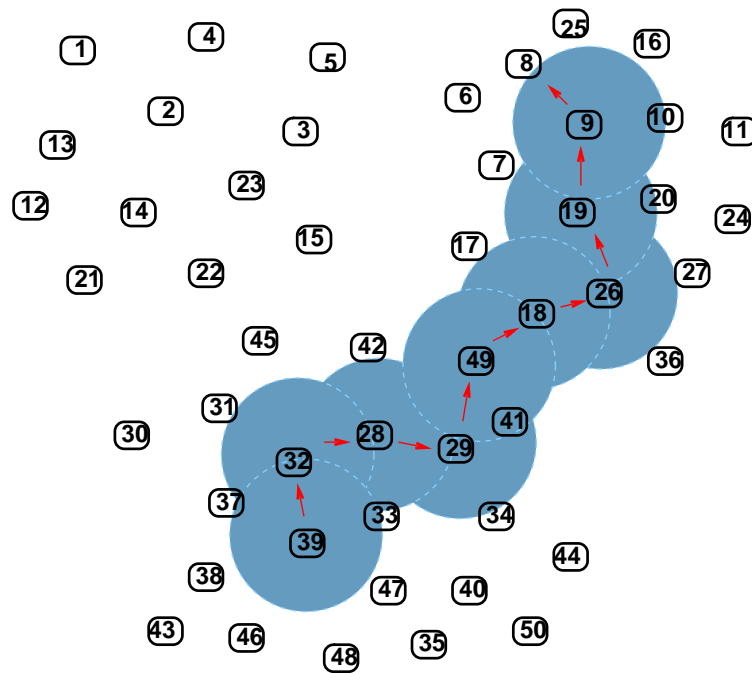

Figure 4.3: Data transmission in ad hoc wireless networks. Dotted circles indicate the radio propagation ranges of nodes at center. The sequence of transmission to send a message from node 39 to node 8 is shaded.

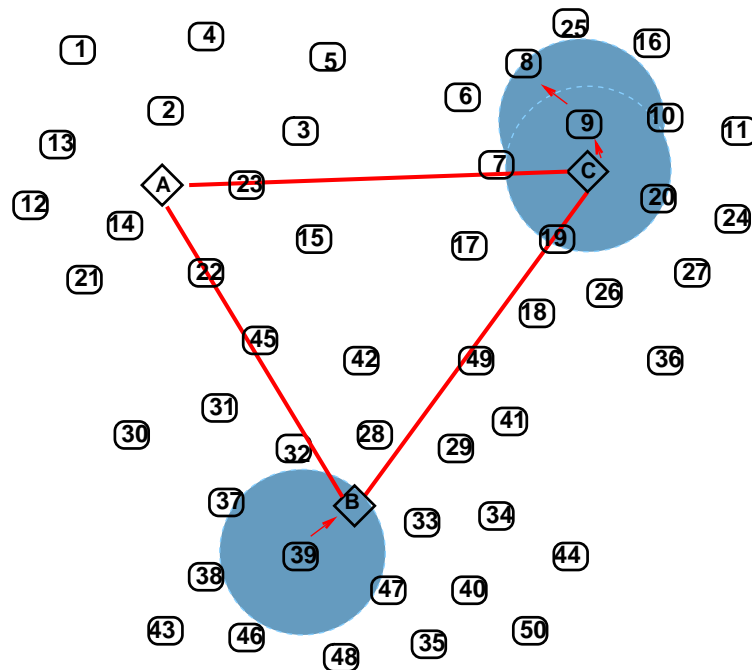

Figure 4.4: Data transmission in mixed wired and wireless networks. Dotted circles indicate the radio propagation ranges of nodes at center. Solid lines between AB, AC and BC indicate point to point (p2p) links such as wired links or long haul wireless links. The sequence of transmission to send a message from node 39 to node 8 is shaded. This transmission uses p2p links between fixed infrastructure nodes B and C.

to wait. So, the actual throughput achieved using wireless links can be significantly less than the specified bandwidth. Using a few fixed infrastructure nodes and wired links, as shown in Figure 4.4, can improve the efficiency significantly by decreasing the use of wireless channels.

Increase stability of routes

Besides higher transmission delays, another important problem in ad hoc networks is the stability of the routes. Since most mobile nodes move randomly and quickly, a node can lose its next hop which causes route breaks. For example, in Figure 4.3, if node 18 moves out of node 49's radio propagation range, all the nodes in the upper right of the figure are isolated from the rest of the network. In a mixed network, such instances are reduced.

4.2 Implementation of ADV Static (ADVS) algorithm

4.2.1 Modifications to ADV

The code for ADVS is in file named *adv.s.c* with the corresponding definitions in *adv.h*. To facilitate simultaneous use of wired and wireless links, we define two new variables: *WIRELESS_METRIC*, which denotes the metric of one wireless hop, and *WIREDWIRELESS_RATIO*, which denotes the ratio of the bandwidth of wired links to the bandwidth of wireless links. So $\frac{WIRELESS_METRIC}{WIREDWIRELESS_RATIO}$ will give us the metric of one wired link hop. We add a variable *wiredLinkCount* to control packets *Initconnection* and *ReceiverAlert* and also to each entry in routing updates. To select a more stable route, we use this variable to track the number of wired links in the route from the sender of the packet to current node. In the routing table entry, we add two variables *wiredLinkCount* and *interfaceId* for the same reason.

Specifying static routes: To facilitate specification of static routes to indicate infrastructure links, ADVS can read static routes specified in a file and put them in appropriate nodes' routing tables. These routing entries are not modified by the dynamic route maintenance mechanism.

we have modified route discovery and maintenance as follows.

Route discovery ADVS uses the route discovery process described for ADV in Chapter 2 except that it keeps track of wired links used by control packets as they are propagated. Also, ADVS sends control packets on both wireless and wired links.

4.2.2 Route maintenance

ADVS increases the stability of routes by using wired links as much as possible. The logic for selecting routes is as shown in Table 4.1. Compared with the routing entry in ADV algorithm, ADVS has two new variables. `My_interfaceId` indicates the MAC interface through which the next hop is reachable. If it is a wireless interface (default interface), this field will be set to 0. Otherwise it will be a positive integer for the corresponding wired interface. In addition to route metric, the number of wired links from the current node to the destination is maintained.

The variable `metricInc` is the cost of link to the neighbor who sent a control packet. It is set to *WIRELESS_METRIC* if the packet comes via a wireless link or $\frac{WIRELESS_METRIC}{WIREDWIRELESS_RATIO}$ if the packet comes via a wired link. The denominator *WIREDWIRELESS_RATIO* gives the factor by which wired links are preferred over wireless links. If a node changes its routing entry to a destination based on a neighbor's control packet (route update, initconnection or receiveralert) packet, then the route cost is calculated as the sum of route cost to neighbor indicated and `metricInc`. `WiredInc` is the increment of the number of wired links counted and used to update `My_wiredCnt` of a route. `my_interfaceId` will be set to 0 if the packet comes via a wireless link and or to a positive number if the packet comes via a wired link.

In ADV routing algorithm, given a pair of routes to a destination, the route with higher sequence number or smaller metric (if both routes have the same sequence number) is selected. In ADVS, we add the factor `my_wiredCnt` in the selection. If there are two routes with the same metric and sequence number, the route with higher wired link count is selected. This selection process ensures that wired links are preferred over

My_Entry	Received_Entry	Condition	Action
Valid	Valid	$my_seqno < recv_seqno$	Update My_Entry with Received_Entry
		$my_seqno == recv_seqno \ \&\&$ $(my_metric > recv_metric + metricInc \ $ $my_metric == recv_metric + metricInc \ \&\&$ $my_wiredCnt < recv_wiredCnt + wiredInc)$	Update My_Entry with Received_Entry
		$my_seqno == recv_seqno \ \&\&$ $(my_metric == recv_metric + metricInc \ \&\&$ $my_wiredCnt == recv_wiredCnt + wiredInc)$	Less advertise the route.
		$(my_seqno > recv_seqno \ $ $my_seqno == recv_seqno \ \&\&$ $my_metric < recv_metric - metricInc) \ $ $(my_seqno == recv_seqno \ \&\&$ $my_metric == recv_metric - metricInc \ \&\&$ $my_wiredCnt == recv_wiredCnt + wiredInc)$	Set advertisement count to help neighbors.
Valid	Invalid	$my_seqno < recv_seqno \ \&\&$ my_hop is source of this update	Invalidate My_Entry since I am dependent on this neighbor Set the advertisement count
		$my_seqno >= recv_seqno$	Set the advertisement count
		$recv_dest == My_Address \ \&\&$ $receiver\ flag == TRUE$	Set triggered update
Invalid	Valid	$my_seqno <= recv_seqno$	Update My_Entry with Received_Entry Set the advertisement count
		$my_seqno > recv_seqno$	Do nothing
Invalid	Invalid	$my_seqno < recv_seqno$	Copy $recv_seqno$ into My_Entry
		$my_seqno > recv_seqno$	Do nothing

Table 4.1: Processing new routing information in a control packet received. my_seqno , my_metric , $my_interfaceId$, $my_wiredCnt$ and my_hop indicate the destination sequence number, hopcount, interface, and the number of wired links in the route and the next hop node currently stored in the entry for $recv_dest$ in the routing table at the node which received this update. $recv_dest$, $recv_seqno$, $recv_metric$ and $recv_wiredCnt$ indicate the values for the destination, sequence number, hop count and the number of wired links in the route in the received routing update entry. my_seqno , my_metric , and my_hop indicate the destination sequence number, hop count, and the next hop node currently stored in the entry for $recv_dest$ in the routing table at the node which received this update. $metricInc$, $wiredInc$ indicate the proper increment of the $recv_metric$ and $wiredCnt$.

wireless links.

Chapter 5

Performance Analysis

In this chapter, we present an analysis of mixed networks and ADVS and compare them with ad hoc networks.

5.1 Simulation Setup

First, we describe the simulation environment.

5.1.1 Node Mobility

The Glomosim simulator has a built-in random node mobility model called random waypoint (RWP), which is extensively used in ad hoc network simulations [13]. In RWP model, each node begins the simulation by remaining stationary for specified seconds, called the pause time, which can be set to 0. Then it selects a random geographical destination in the simulated field. It moves to the destination at a speed randomly selected between minimum and maximum specified node speeds. Upon reaching the geographical destination, the node pauses again for the specified amount of pause time. This behavior is repeated for the duration of the simulation. The RWP model has two disadvantages. If the geographical destination is not in the field, the node will reselect a new destination. This is repeated until a geographical destination within the field is selected. This causes all mobile nodes to move toward the center of the square with higher probability, which results in clustering of majority of nodes in the middle of the field. Another disadvantage is if a node's speed is chosen to be very low or 0 m/s, it could stay at that speed for the remainder of simulation.

So the average node speed tends to decrease with time if the minimum node speed is 0 m/s [32].

We modified the RWP model slightly to address the problem of clustering in the middle of the field. In our model, a node may choose a geographical destination that is outside the field. If a node reaches the boundary of a field, it reenters the field immediately from the other (parallel) side of the field with the same speed and direction and completes the remaining distance. We call this RWP with wraparound model. We also choose a random speed for node movement to vary between 1 m/s and 29 m/s (108Km/hr). This mitigates the second disadvantage of RWP. We simulated only continuous node mobility with 0-second pause times.

5.1.2 Types of Links

We used two types of links for simulations. One type is the wireless link whose bandwidth is 2 Mb/s with a radio range of 376 m. This is consistent with the 802.11 protocol implemented in Glomosim. The other type is a point-to-point (p2p) link. This can be a wired or long haul wireless link based on, for example, IEEE 802.16. Since wired links are supported by Glomosim, we used wired links with 2 Mb/s bandwidth, 2.5 μ sec propagation delay and full-duplex capability as the p2p links among infrastructure nodes. We limited the bandwidth of wired links to 2 Mb/s to show that even with such low bandwidth, mixed networks can outperform ad hoc wireless networks significantly. For route selection purposes, we set the wired link to wireless link ratio, r , to 10. Based on our experience and several published results [5], an ad hoc network with 50-100 nodes and several simultaneous connections in a 1.5 to 2.5 sq. km area typically achieves a throughput of about 1/5th of maximum wireless channel BW (2 Mbps in our simulations) for UDP traffic, while a point-to-point link can achieve throughput very close to its nominal BW. Since we use full duplex p2p links and half-duplex wireless links, a ratio of 10 seemed appropriate.

5.1.3 Types of Networks

We simulated small (50-nodes in a 1.5×1.5 Km² field) and large (1000 nodes in a 6×6 Km² field) ad hoc and mixed networks. We simulated three types of small networks: (a) 50 mobile nodes with only wireless capability (Figure 5.1), (b) 50 mobile nodes and additional 9 fixed nodes, with only wireless capability

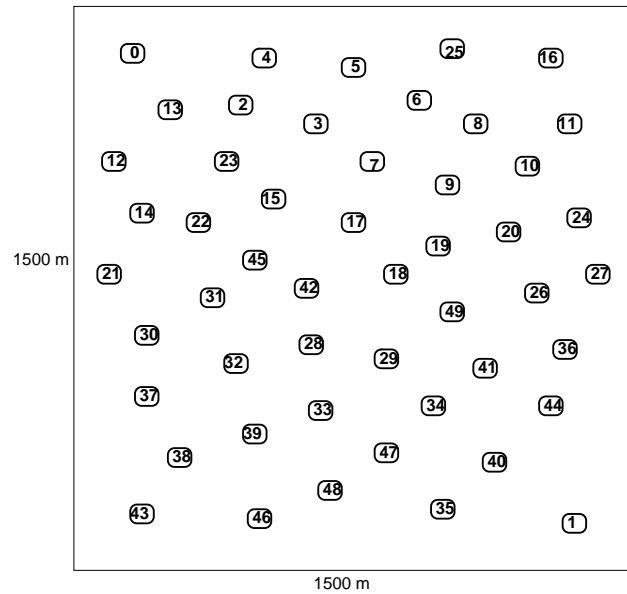

Figure 5.1: Fifty-node wireless network in a field of 1500m x 1500m. Rectangular boxes with rounded corners and numbers inside indicate mobile nodes.

(Figure 5.2), and (c) 50 mobile nodes with wireless capability and 9 fixed nodes with wireless capability and 12 wired links among them (Figure 5.3). The 9 fixed nodes form a 3×3 grid in the middle of the field. The distance between adjacent fixed infrastructure nodes is 500m. So they can not communicate with one another directly with wireless links. We simulated three large networks: (a) 1000 mobiles nodes with only wireless capability; (b) 991 mobile nodes, 9 fixed nodes with wireless capability and 12 p2p links among them; and (c) 975 mobiles and 25 fixed nodes with wireless capability and 40 p2p links. In both small and large networks, we ensured that fixed nodes are neither source nor destination nodes.

As explained in chapter 3, we modified Glomosim simulator so that a specified list of stationary nodes can be placed at predetermined locations, while the remaining nodes are placed randomly in the field with the specified mobility model.

5.1.4 Traffic Models

We used UDP and TCP traffic patterns to evaluate mixed networks and ADVS . We used constant bit rate (CBR) to simulate UDP traffic and HTTP and FTP to simulate TCP traffic. We vary the network load for the case of CBR traffic by varying the packet rates of 25 CBR connections. The packet size is fixed at 512

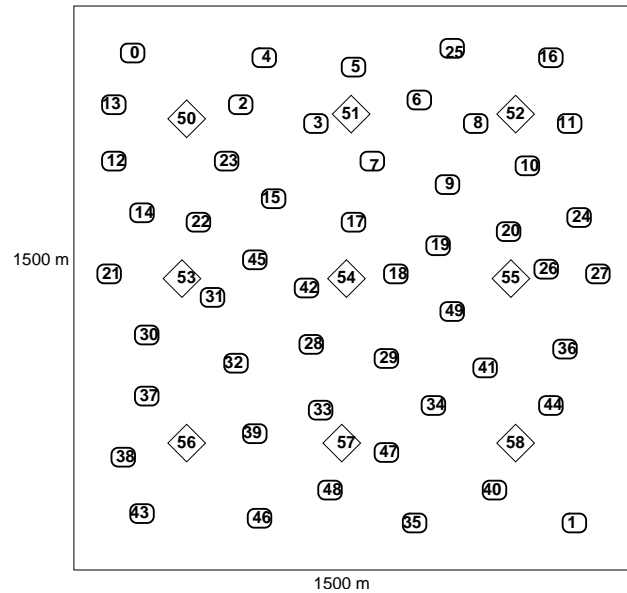

Figure 5.2: Fifty nine-node wireless network with 50 mobile and 9 fixed nodes. Rectangular boxes with rounded corners and numbers inside indicate mobile nodes. Diamond shape boxes with numbers inside indicate fixed infrastructure nodes with the radio propagation range as same as mobile nodes.

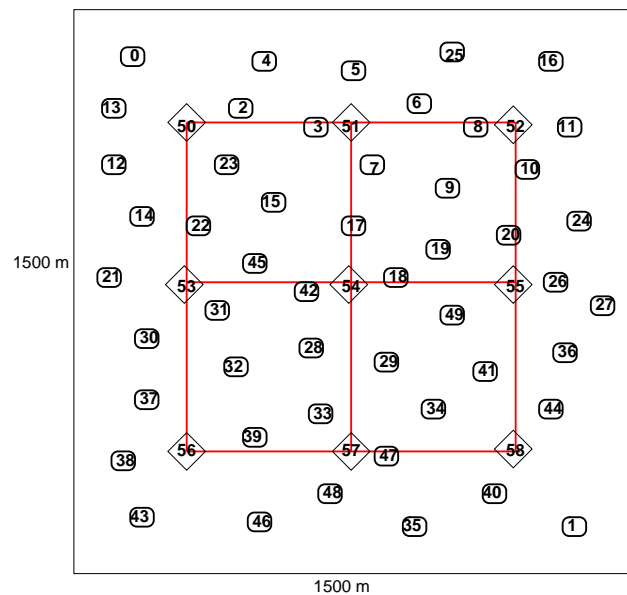

Figure 5.3: Mixed network with 50 mobile nodes and 9 fixed nodes. All nodes have the capability to use wireless channels. In addition, fixed nodes have point-to-point links indicated as lines connecting them as a rectangular grid.

bytes. We vary the network load for TCP traffic by varying the number of HTTP and FTP connections. HTTP traffic is generated using the built-in Glomosim model, which is based on the Zipf law [23].

For small networks, 10 scenarios are generated with different random mobile node placements at the start of simulation. Each data point presented here is an average of 10 such simulations. This minimizes any skewing of results based on a particularly good or bad scenario. For large networks, each data point presented here is an average of 5 simulations. Each simulation is run for 600 seconds.

5.1.5 Routing protocols

We implemented ADVS in Glomosim. We used ADVS for all types of networks. For ad hoc wireless networks, ADVS is the same as ADV. In addition, we also simulated AODV routing protocol for ad hoc wireless networks (distributed with Glomosim code) to illustrate that the results obtained with ADV are representative of the performance achievable in wireless ad hoc networks. So any performance improvements by ADVS in mixed networks are clearly due to the use of p2p links.

5.1.6 Static Routes

Glomosim lets static route specification and usage when a dynamic routing protocol is not used. Because of this, when static route option is used, all possible routes need to be specified, and the routes cannot change during the simulation. This is not feasible with mobile nodes. So we implemented ADVS such that it can read wired links with which two nodes are connected specified in a file and put them in appropriate nodes' routing tables. The static p2p links do not fail and are not modified by the dynamic route maintenance mechanism. Each p2p link indicates a 1-hop static route between the nodes it connects.

5.1.7 Metrics and Parameters

We used following metrics to evaluate the routing protocols and networks:

- *Throughput*: The total amount of data (in Kb/s) delivered to the destinations.

- *Average packet latency*: The time, in milliseconds, it takes for a data packet to reach its destination from the time it is generated at the source and includes all the queuing and protocol processing delays in addition to propagation and transmission delays.
- *Routing Overhead on wireless links (pkts/s)*: The number of routing packets transmitted per second by the routing layer to MAC layer. For packets sent over multiple hops, each transmission of the packet (each hop) counts as one transmission. This is the routing overhead seen at the routing layer level.

We also examined secondary metrics such as MAC layer network allocation vector, which indicates channel contention, hop counts, and the rate of broken routes to illustrate the reasons for performance differences among routing protocols and networks.

5.2 Small Ad Hoc Networks

ADVS is used to denote ADVS routing protocol in the 59-node mixed network and ADV 50 and ADV 59 are used to denote ADV in 50-node and 59-node wireless networks, respectively. AODV 50 indicates the performance of AODV for the 50-node wireless network. The 25 CBR connections simulated use nodes 0-24 as senders and nodes 25-49 as destinations. To avoid using senders or destinations as fixed nodes, which could skew the results in favor of mixed networks, we have used 9 separate nodes as fixed infrastructure nodes in the small ad hoc network case. For this reason we simulated a 59-node mixed network. To show that adding 9 extra nodes without p2p links is not beneficial, we also simulated a 59-node wireless network with 50 mobile and 9 fixed nodes.

5.2.1 UDP traffic

First, we evaluate the networks using UDP traffic, which is simulated using 25 CBR connections and the size of each packet is 512 bytes. Figure 5.4 give the throughputs of ADVS, ADV 59, ADV 50 and AODV 50. Figure 5.5 gives the corresponding delivery rates, where a delivery rate is the fraction of the injected packets that were delivered to destinations.

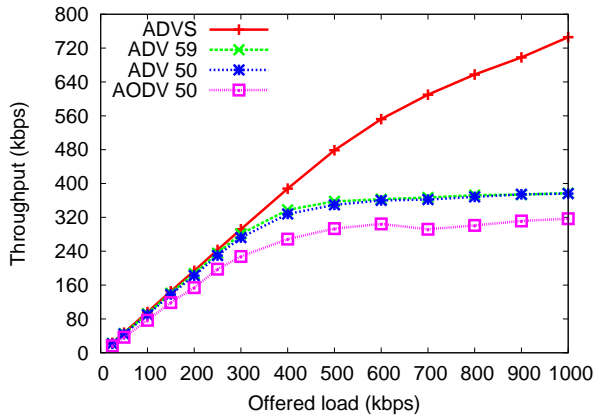

Figure 5.4: Throughputs achieved for CBR traffic on 50/59-node ad hoc networks.

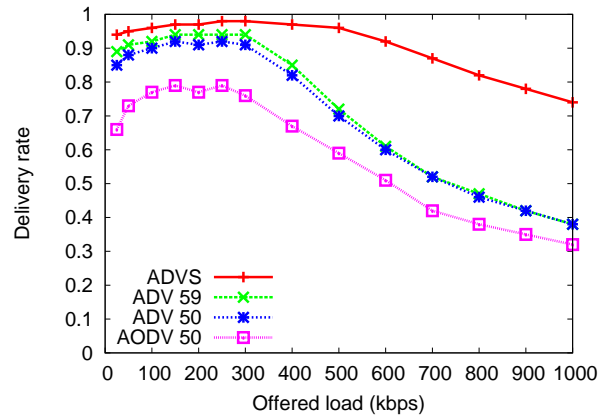

Figure 5.5: Delivery rate on 50/59-node ad hoc networks.

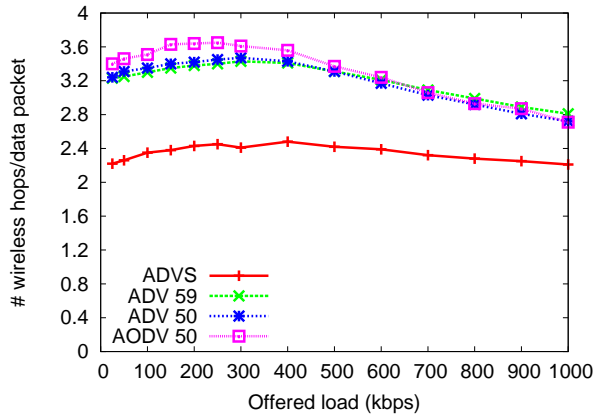

Figure 5.6: The number of wireless hops taken by each data packet on 50/59-node ad hoc networks.

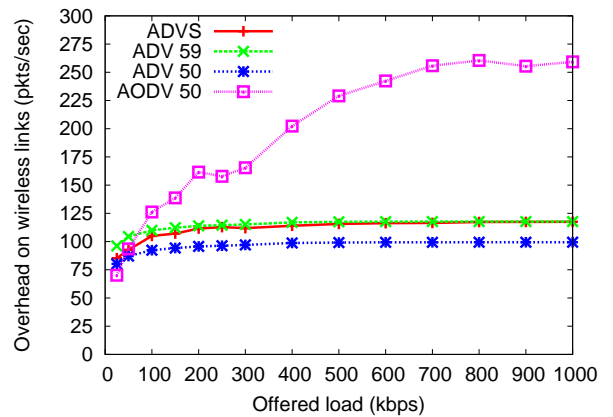

Figure 5.7: Overheads on wireless links achieved for CBR traffic on 50/59-node ad hoc networks.

We notice in Figure 5.4 that the maximum throughput achieved with ad hoc wireless networks is 380 Kb/s. In the mixed network, the max throughput is 750 Kb/s, nearly twice as much. Since ADV 59 and ADVS have the same number of mobile and fixed nodes, it is clear that the increase in performance is due to p2p links. To understand the reasons for this increase in performance, we examined the number of wireless hops taken by data packets. Figure 5.6 shows that the average number of wireless hops taken by a delivered packet in mixed networks is around 2.35 and that for wireless networks with ADV 50, ADV 59 or AODV is about 3.22. So the load placed on wireless links is reduced by $\frac{3.22-2.35}{2.35} = 37\%$. This accounts for some of the throughput increase we observed.

The rest of the improvement in throughput with p2p links is due to two factors: (a) less interference of transmission on wireless links because fewer wireless links used by a data packet; (b) ADVS reduces the probability of broken routes and provides more stable routes by using wired links as much as possible. To show that p2p links reduce interference on wireless channels significantly, we examined the network allocation vector (NAV) at the MAC layer. This NAV indicates the duration wireless channel is reserved at any instant of time; smaller NAV means reduced contention. We sampled NAV each time MAC protocol needs to transmit a packet and calculated the average NAV. Figure 5.8 presents the average NAV observed for various protocols and networks. The average NAV is indicative of the network performance before the network is saturated (Beyond saturation, NAV does not indicate network performance properly due to frequent broken routes and increased use of channel BW for control packets.) Based on this we see that the average NAV for mixed network is about 50% smaller than that of the wireless networks. To examine the second factor, we calculated the rate of route breaks in each type of network. The rate of broken routes is shown in Figure 5.9. Mixed network has much fewer broken routes than the wireless networks. It is particularly interesting to compare ADV and ADVS. The rate of broken routes increases rapidly for loads beyond 300 Kbps for ADV, while it is more gradual for ADVS. AODV has a higher rate of broken routes prior to saturation; this rate is bounded in saturation because it takes more time to repair routes compared to other algorithms and most routes stay broken for extended periods of time.

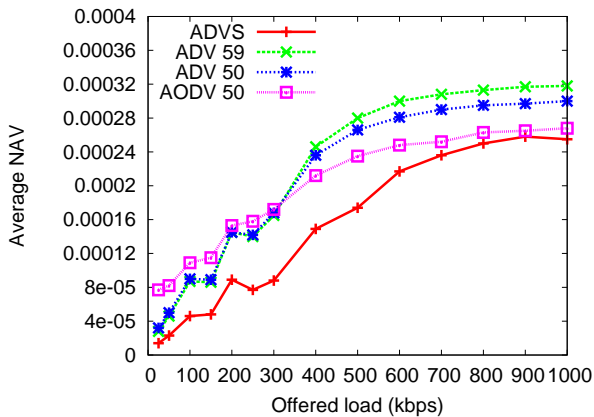

Figure 5.8: Average Network Allocation Vector(NAV) on 50/59-node ad hoc networks.

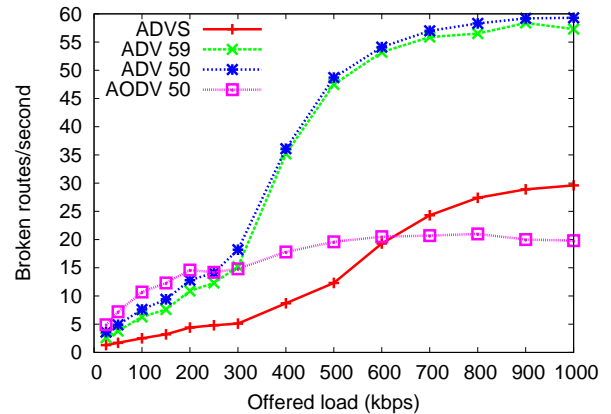

Figure 5.9: Average broken routes on 50/59-node ad hoc networks.

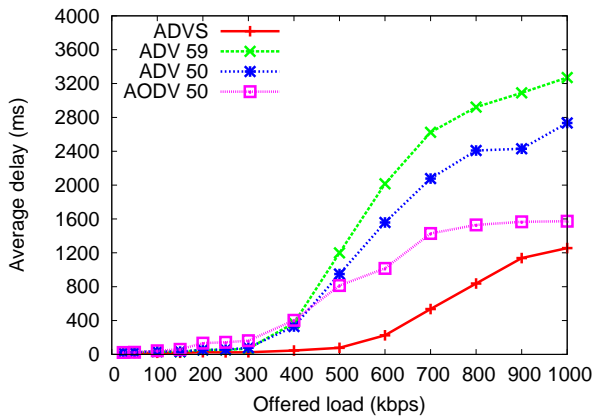

Figure 5.10: Average delays achieved for CBR traffic on 50/59-node ad hoc networks.

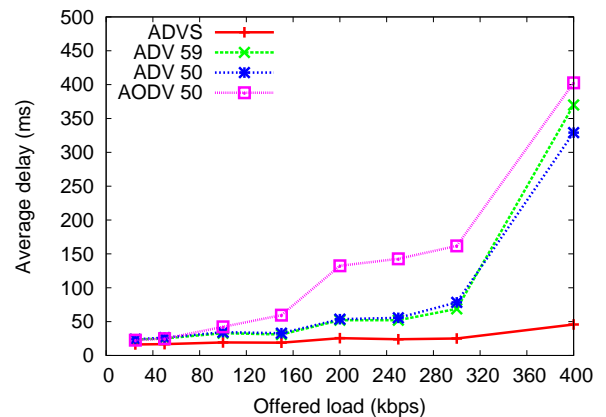

Figure 5.11: Average delays (offerloads from 0 to 80 kbps) achieved for CBR traffic on 50/59-node ad hoc networks.

It is noteworthy that even though the wired link bandwidth is 2 Mb/s, adding 12 p2p links nearly doubles the throughput. If we use wired links with higher bandwidth, the throughput will be improved even further.

Figure 5.10 gives average packet delays. At low to moderate loads (less than 150 kbps), all networks have comparable delays. As the load increases, the wireless networks saturate and packet delays grow rapidly. However, the mixed network saturates at higher loads and packet latencies do not grow as fast as in the other networks. Figure 5.11 gives an enlarged view of packet delays prior to saturation. This figure shows loads varying from 0 to 400 kbps. It is clear that even in uncongested networks, mixed network provides lower latencies.

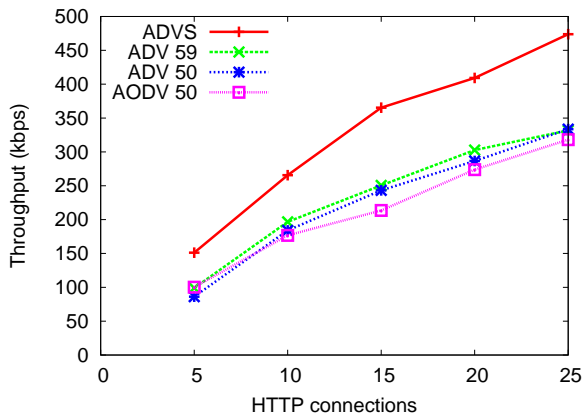

Figure 5.12: Throughputs achieved for HTTP traffic on 50/59-node ad hoc networks. Each server has one client.

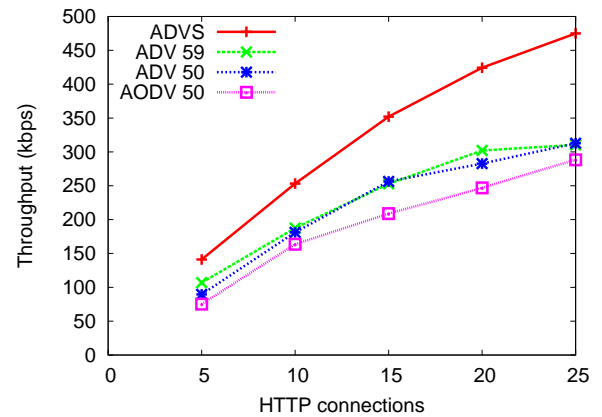

Figure 5.13: Throughputs achieved for HTTP traffic on 50/59-node ad hoc networks. Each server has three clients.

Figure 5.7 gives the CBR traffic overheads for the three networks. We notice that the overheads of ADVS, ADV 59 and ADV 50 are nearly constant as the offered load increases. But AODV has significantly higher overhead owing to its on demand approach of discovering and maintaining routes. Routing algorithms such as ADV which control the number of control packets tends to perform better in congested networks.

5.2.2 TCP traffic

We have simulated TCP traffic using HTTP and FTP applications. In Figure 5.12, we show the throughput achieved for the case where HTTP server serves one client. Figure 5.13 shows the throughput achieved for the case when each server has three clients. Comparing these two figures, we find that the performance of AODV drops slightly with the increase in the number of servers. ADV 50 and ADV 59 perform similarly indicating that the infrastructure nodes by themselves do not improve performance. ADVS gives significantly higher throughput (50% more) compared to ADV 50 and ADV 59. AODV underperforms ADV in most instances.

Figure 5.14 and Figure 5.15 show the overheads of two HTTP configurations. In both cases, with the increase in the number of connections, the overheads of ADV 50, ADV 59 and ADVS reach a maximum value and do not exceed this value since the ADV algorithm limits update packets to 2 per second per

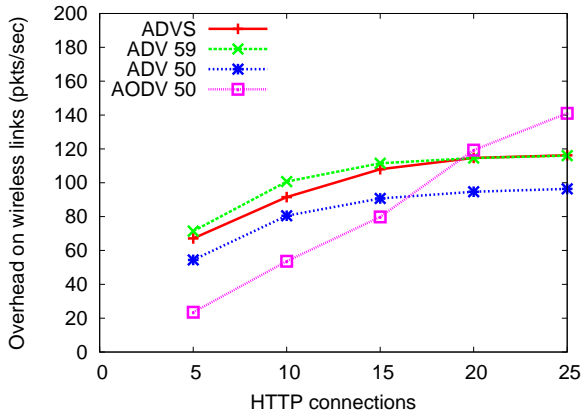

Figure 5.14: Overheads on wireless links achieved for HTTP traffic on 50/59-node ad hoc networks. Each server has one client.

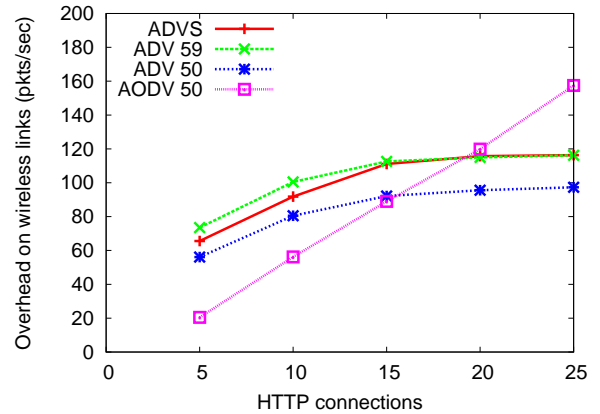

Figure 5.15: Overheads on wireless links achieved for HTTP traffic on 50/59-node ad hoc networks. Each server has three clients.

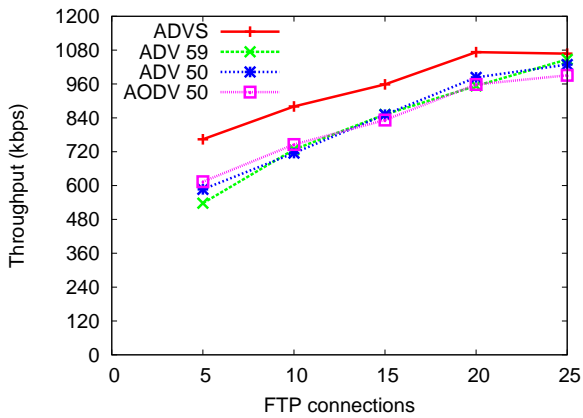

Figure 5.16: Throughputs achieved for FTP traffic on 50/59-node ad hoc networks.

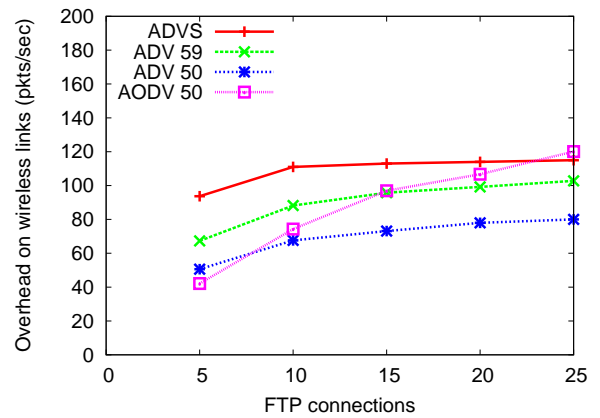

Figure 5.17: Overheads achieved for FTP traffic on 50/59-node ad hoc networks.

node. But the overhead of AODV increases with the increase in number of connections, primarily due to maintaining routes individually.

Figure 5.16 gives throughputs of various networks for FTP traffic. With the increase in the number of connections, the throughput advantage of mixed network over other networks decreases. TCP uses backoff when the network is congested and uses available bandwidth as much as possible. So, in ad hoc networks, TCP performs better than UDP [12]. Since an FTP connection has infinite amount of data to transmit and the available bandwidth of wired links has already been used as much as possible, even with a few connections, the additional throughput realized with increased number of connections is reduced. Figure 5.17 give the

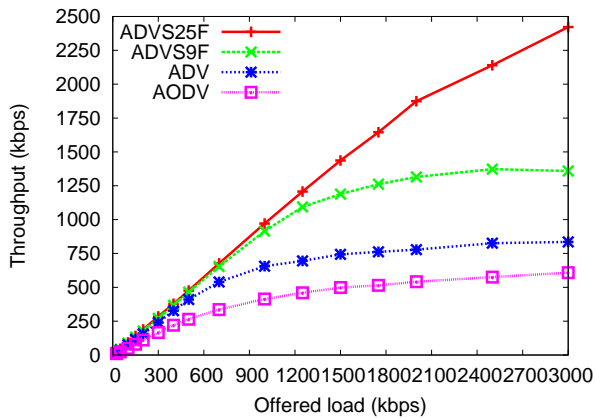

Figure 5.18: Throughputs achieved for CBR traffic on 1000-node ad hoc networks.

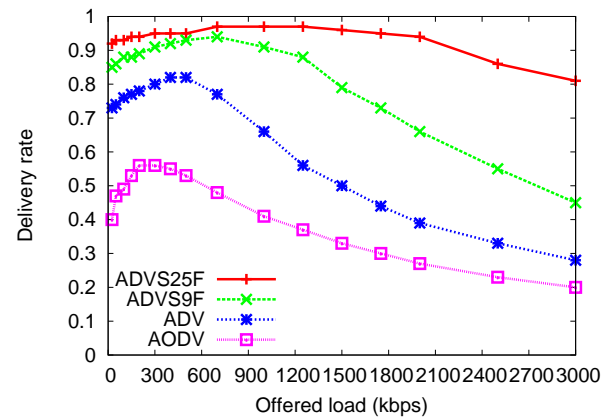

Figure 5.19: Delivery rates for CBR traffic on 1000-node ad hoc networks.

FTP traffic overheads which are similar to those seen for HTTP traffic.

To summarize our results for small networks, we note that the throughputs and average delays achieved by ADV 59 are almost the same as those by ADV 50. That is because the 9 fixed nodes in ADV 59 have only wireless capability and just act as intermediate nodes. But we can achieve significant improvement in performance by adding wired point-to-point links among infrastructure nodes.

5.3 Large Ad Hoc Networks

ADVS25F denotes ADVS routing protocol in a 1000-node network with 25 fixed nodes and ADVS9F the same for 1000-node network with 9 fixed nodes. ADV and AODV are used to denote ADV and AODV routing protocols in networks with 1000 mobile nodes.

UDP traffic

We evaluate the networks using UDP traffic, which is simulated using 25 CBR connections sending 512-byte packets. Figures 5.18 and 5.19 give the CBR traffic throughputs and delivery rates of ADVS25F, ADVS9F, ADV and AODV.

The maximum throughput achieved with ad hoc wireless networks using ADV routing protocol is 835 kb/s. In the mixed network, the max throughput of ADVS9F is 1359 kb/s, 63% higher, and that of ADVS25F is 2421 Kb/, 190% higher. Once again mixed networks provide significantly higher performance for similar reasons: lower wireless channel contention (given in Figure 5.22), reduced number of wireless hops (shown in Figure 5.20), and fewer broken routes (given in Figure 5.23). What is noteworthy, however, is that the performance is improved with only a few fixed nodes and p2p links in the large network. The number of fixed nodes is a small percentage (0.9 to 2.5%) of the total number of nodes. (In contrast, the number of fixed nodes is 15% of the total nodes in the 59-node mixed network.) The number of p2p links used is 12 with 9 fixed nodes or 40 with 25 fixed nodes. Yet the performance improvement is even higher than that seen for smaller networks.

Figure 5.20 show that the average number of wireless hops taken by a delivered packet. When the offered load is 2000 Kb/s, the mixed network with 9 fixed nodes delivers a throughput of 1315 Kb/s with an average of 6.9 wireless hops per delivered data packet. In contrast, the ad hoc network with no fixed nodes delivers a throughput of 778 Kb/s with an average of 9.4 hops (all hops are wireless in this network) per delivered data packet. So $\frac{9.4-6.9}{6.9} = 36\%$ wireless hops are saved by adding 12 extra wired links. This accounts for some of the 57% throughput increase we observed. Since in large ad hoc networks, each route involves more wireless hops and is broken more easily, ADVS25F improves the performance even more since more mobile nodes can directly access fixed nodes. The performances of ADV and AODV illustrate why pure ad hoc networks can only be useful in small areas.

As shown in Figure 5.19, among the ad hoc protocols, ADV is able to perform adequately achieving 70% or higher delivery rates prior to saturation and peak throughput of 835 Kbps. AODV does not perform well and saturates much more quickly with a peak throughput of 608 Kbps. Even at low loads, its delivery rate is less than 56%.

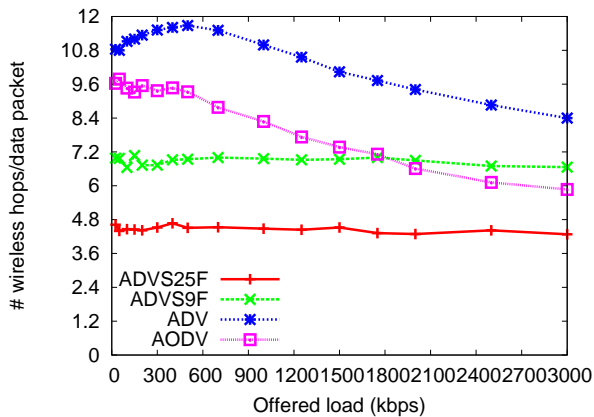

Figure 5.20: The number of wireless hops taken by a data packet in 1000-node ad hoc networks.

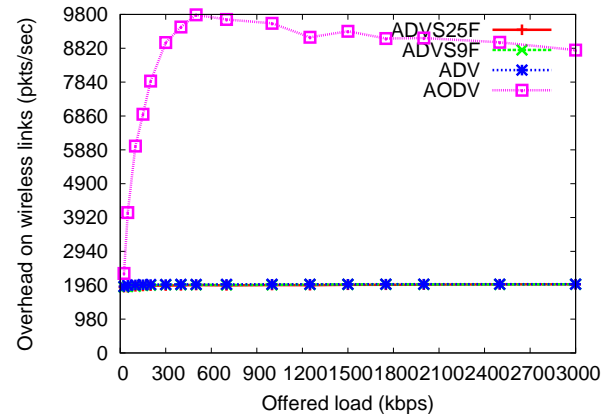

Figure 5.21: Overheads on wireless links achieved for CBR traffic on 1000-node ad hoc networks.

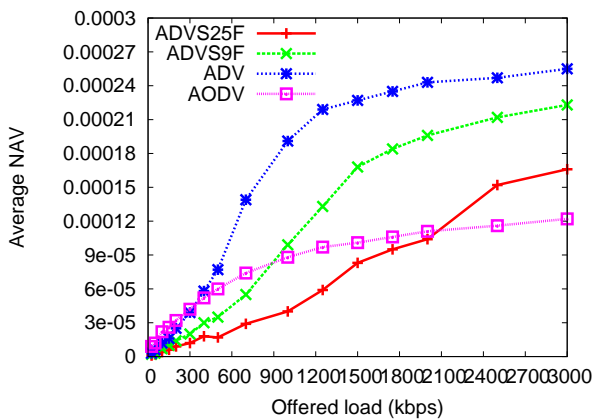

Figure 5.22: Average Network Allocation Vector(NAV) value for various 1000-node ad hoc networks.

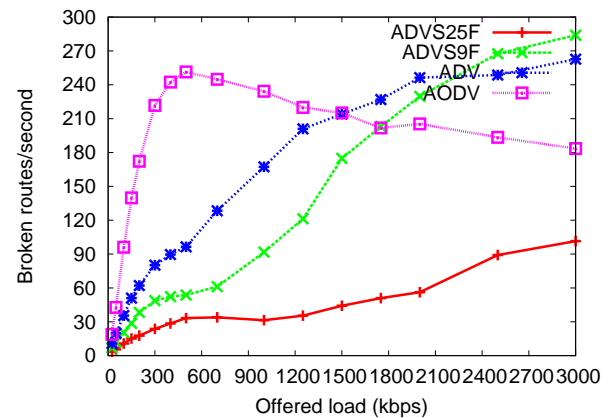

Figure 5.23: Average broken routes in CBR simulation on 1000-node ad hoc networks.

It is noteworthy that even though the wired link bandwidth is 2 Mb/s, adding 40 p2p links among 25 fixed nodes nearly triples the throughput. If we use wired links with higher bandwidth, the throughput may be improved even further.

Figure 5.24 shows that average packet latencies are manageable mixed networks, but too high in ad hoc networks to facilitate interactive applications such as voice over IP or online gaming. At low to moderate loads (less than 150 kbps), all networks have comparable delays. As the load increases, the wireless networks saturate and packet delays grow rapidly. In contrast, the mixed networks saturate at higher loads and packet latencies do not grow as fast as in the other networks. Figure 5.25 gives an enlarged view of

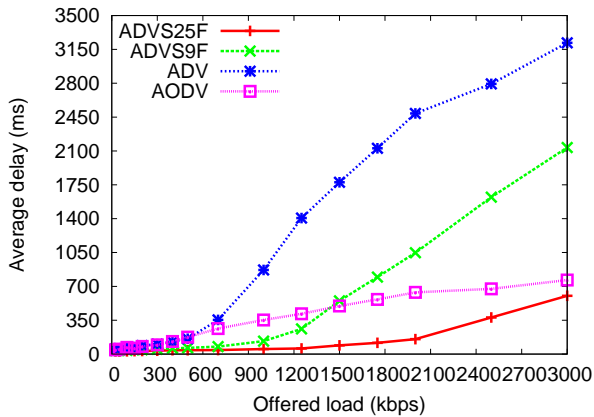

Figure 5.24: Average delays achieved for CBR traffic on 1000-node ad hoc networks.

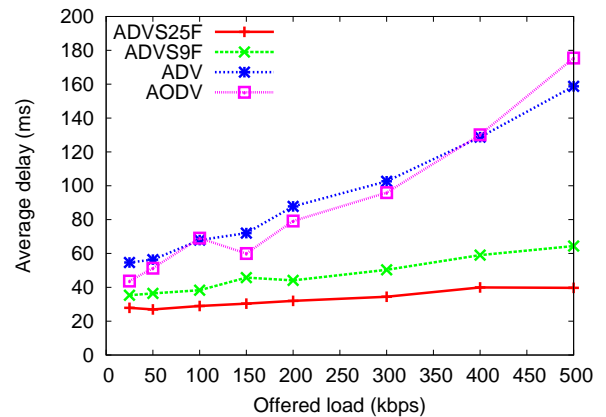

Figure 5.25: Average delays (offerloads from 0 to 500 kbps) achieved for CBR traffic on 1000-node ad hoc networks.

packet delays prior to saturation. This figure shows loads varying from 0 to 500 kbps. It is clear that even in uncongested networks, mixed network provides lower latencies.

Figure 5.21 gives the CBR traffic overheads for the three networks. We notice that overheads with ADVS25F, ADVS9F and ADV are nearly constant as the offered load increases. But AODV has significantly higher overhead owing to its on demand approach of discovering and maintaining routes.

5.3.1 TCP Traffic

We have simulated TCP traffic using varying number of HTTP connections. Figure 5.26 shows the throughput achieved for the case where each HTTP server serves five clients. Figure 5.27 shows the throughput achieved for the case when each server has 10 clients.

It is noteworthy that the throughput goes up by almost 5 times in the mixed networks. We get even more throughput improvement for HTTP than CBR since HTTP is based on TCP which makes connections before transmission. The reliable route can keep the connection alive for even longer and reduce the overhead to build connections. Since infrastructure nodes provide more reliable routes, the need for route discovery for each HTTP session is reduced.

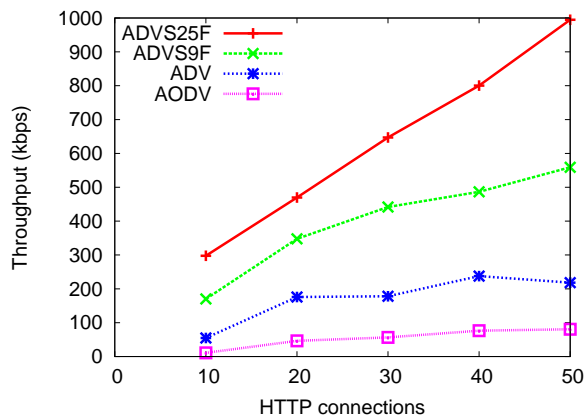

Figure 5.26: Throughputs achieved for HTTP traffic on 1000-node ad hoc networks. Each server has five clients.

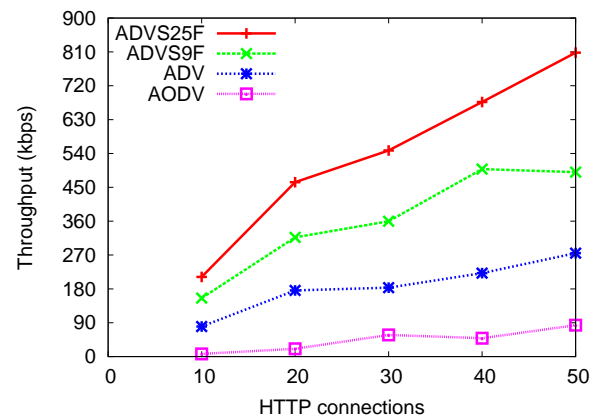

Figure 5.27: Throughputs achieved for HTTP traffic on 1000-node ad hoc networks. Each server has ten clients.

Chapter 6

Conclusions

With the advent of ad hoc wireless networks, there are more and more demands on them to take advantage of the flexibility and provide easy access to the Internet, but still have the stable and high performance characteristics of the traditional wired networks. We have proposed mixed networks that are primarily ad hoc wireless networks with some fixed nodes with p2p links added to provide better performance and reliability. Recently a few other researchers also started investigating mixed networks [2, 21, 4].

It is feasible to deploy the proposed mixed networks inexpensively. The IEEE 802.11 is a popular MAC protocol for ad hoc wireless networks as a short-haul wireless link protocol. The p2p links among infrastructure nodes can be wired links or long haul wireless links such as IEEE 802.16 wireless link protocol. The infrastructure nodes can even be already existing fixed nodes connected via p2p links (for example, access points connected to the Internet). Or these could be semi-permanent nodes that remain stationary for a few hours and have p2p links implemented via a suitable wireless technology, for example, IEEE 802.16.

We proposed a routing algorithm, denoted ADVS, that can work well in ad hoc networks as well as mixed networks we proposed. We implemented ADVS in the Glomosim simulator. Also, we modified Glomosim to simulate mixed networks.

We have shown using simulations that mixed networks perform significantly better than ad hoc networks. For UDP and TCP traffic, mixed networks can provide significantly higher throughput and lower packet

delays. We simulated a large ad hoc network with 1000 nodes in a 36 Km² area to see the practicality of ad hoc networking in a reasonably large geographical region. While pure ad hoc networks are unusable, adding a few infrastructure nodes with p2p links offers high throughput and low delays.

Future work

In future, we would like to evaluate mixed networks and ADVS using real time video applications. Another interesting topic to explore is optimal placement of fixed nodes and links and possibly using multiple wireless channels by fixed nodes. We also would like use 802.16 based wireless links instead of wired links as point-to-point links among infrastructure nodes. We are also interested in robust low overhead security protocols that take advantage of the infrastructure nodes in mixed networks to facilitate authentication and key management.

Bibliography

- [1] R Bagrodia et al. Glomosim: A scalable network simulation environment, v2.03. Parallel Computing Lab, UC Los Angeles, CA. <http://pcl.cs.ucla.edu/projects/glomosim>, December 2000.
- [2] P. Bhagwat, B. Raman, and D. Sanghi. Turning 802.11 inside-out. In *Proceedings of HotNets-II*, 2003.
- [3] R. V. Boppana and S. P. Konduru. An adaptive distance vector routing algorithm for mobile, ad hoc networks. In *Proceedings of IEEE Infocom*, April 2001.
- [4] S. R. Das, R. Castaneda, and J. Yan. Simulation based performance evaluation of mobile, ad hoc network routing protocols. In *Seventh Int'l Conf. on Computer Communication and Networks*, 1998.
- [5] S. R. Das, C. E. Perkins, and E. M. Royer. Performance comparison of two on-demand routing protocols for ad hoc networks. In *Proceedings of IEEE Infocom 2000*, March 2000.
- [6] IEEE Standards Department. IEEE 802.3 standard for local area networks – carrier sense multiple access with collision detection (CSMA/CD) access method and physical layer specifications, 1985.
- [7] IEEE Standards Department. IEEE 802.11 standard for wireless LAN, medium access control (MAC) and physical layer (PHY) specifications, 1997.
- [8] IEEE Standards Department. IEEE Bluetooth standard: Wireless mac and phy specifications for wireless personal area networks, 1997.
- [9] IEEE Standards Department. IEEE 802.16 standard: Wirelessman standard for broadband wireless metropolitan area networks, 2004.
- [10] IEEE Standards Department. IEEE 802.20 standard: Mobile broadband wireless access (MBWA), 2004.
- [11] T. D. Dyer. *Design and Analysis of Adaptive Routing and Transport Protocols in Mobile Ad Hoc Networks*. PhD thesis, The University of Texas at San Antonio, 2002.
- [12] T. D. Dyer and R. V. Boppana. A comparison of TCP performance over three routing protocols for mobile ad hoc networks. In *Proceedings of ACM Mobihoc*, October 2001.
- [13] J. Broch et al. A performance comparison of multi-hop wireless ad hoc network routing protocols. In *Proceedings of ACM Mobicom'98*, Oct. 1998.
- [14] P. Johansson et al. Scenario-based performance analysis of routing protocols for mobile ad hoc networks. In *Proceedings of ACM Mobicom*, 1999.

- [15] R. Sivakumar et al. Cedar: Core extraction distributed ad hoc routing. *IEEE Journal on Selected Areas in Communication, Special Issue on Ad hoc Networks*, pages Vol 17, No.8, 1999.
- [16] J. Foerster, E. Green, S. Somayazulu, and D. Leeper. Ultrawide band technology for short or medium range wireless communications. *Intel Technology Journal*, pages vol. 5, no. 2, 2001.
- [17] Z. J. Haas and M. R. Pearlman. The zone routing protocol (zrp) for ad hoc networks. *IETF Internet Draft, draft-ietf-zone-zrp-00.txt*, 1997.
- [18] C. Hedrick. Routing information protocol. *Internet RFC 1058*, 1988.
- [19] M. Jiang, J. Li, and Y.C. Tay. The cluster based routing protocol (cbrp) for ad hoc networks. *IETF Internet Draft, draft-ietf-manet-cbrp-spec-01.txt*, 1999.
- [20] David B Johnson and David A Maltz. The dynamic source routing in ad hoc wireless networks. In *Internet Draft, draft-ietf-manet-dsr-03.txt*, 1999.
- [21] R. Karrer, A. Sabharwal, and E. Knightly. Enabling large-scale wireless broadband: The case for taps. In *Proceedings of HotNets-II*, 2003.
- [22] S. P. Konduru. An adaptive distance vector routing algorithm for mobile, ad hoc networks. Master's thesis, The University of Texas at San Antonio, 2000.
- [23] L. Breslau, P. Cao, L. Fan, G. Phillips, and S. Shenker. Web caching and zipf-like distributions: evidence and implications. In *Proceedings of INFOCOM'99 (IEEE Press)*, 2000.
- [24] S. Lee, Mario Gerla, and C. K. Toh. A simulation study of table-driven and on-demand routing protocols for mobile ad hoc networks. *IEEE Network Magazine*, August 1999.
- [25] S. Mehra and C. Yu. Enhancing the performance of mobile ad hoc networks with the aid of internet gateways. In *ICWN 2004 International Conference*, 2004.
- [26] J. Moy. Ospf version 2. In *Internet RFC 1583*, March 1994.
- [27] C. E. Perins and P. Bhagwat. Highly dynamic destination-sequenced distance vector (dsv) for mobile computers. In *Proceedings of ACM SIGCOMM'94*, pages 234–244, 1994.
- [28] C. E. Perkins, E. M. Moyer, and S. R. Das. Ad hoc on demand distance vector (AODV) routing. *IETF, Internet Draft, IEEE RFC 3561, <http://www.ietf.org/rfc/rfc3561.txt?number=3561>*, July 2003.
- [29] Peterson and Davie. *Computer Networks: A systems approach*, volume 3rd edition. Morgan Kaufmann, 2003.
- [30] E. Royer and C. K. Toh. A review of current routing protocols for ad hoc mobile wireless networks. *IEEE Personal Communications Magazine*, pages Vol 6, No.2, April 1999.
- [31] C. Toh. Associativity based routing protocol (abr) for ad hoc networks. *IETF Internet Draft, draft-ietf-manet-longlived-adhoc-routing-00.txt*, 1999.
- [32] J. Yoon, M. Liu, and B. Noble. Random waypoint considered harmful. *IEEE INFOCOM*, 2003.

Vita

Zhi Zheng was born in Xin Jiang, China on June 12, 1978, the son of Jingren Zheng and Lianrui Du. In 2001, he graduated from Beijing University of Posts and Telecommunications, receiving the Bachelor of Engineering with a major in Computer Science . He entered the graduate program at UTSA in 2002.

He can be reached at *tylerzheng@yahoo.com*.

Publications in Computer Science

R.V. Boppana and Z.Zheng, "Improving Performance of Wireless Ad Hoc Networks Using a Few Point-to-Point Links.", Wireless Network Communications Group(WCNG) Symposium, 2004.

R.V. Boppana and Z.Zheng, "On the Performance of Wireless Metropolitan Area Networks.", in the Proceedings of IEEE Wireless Communications and Networking Conference (WCNC), 2005.

R.V. Boppana and Z.Zheng, "Designing Ad Hoc Networks with Limited Infrastructure Support.", in the Proceedings of IEEE Wireless Consumer Communications and Networking Conference (CCNC) , 2005